

GIR 35 UK 2RS INA

TYPE: Plain bearings, Spherical plain bearings and rod ends, Rod ends, Maintenance free, With internal thread, with lip seals or high performance seals, right hand thread, series GIR..-UK-2RS (INA)

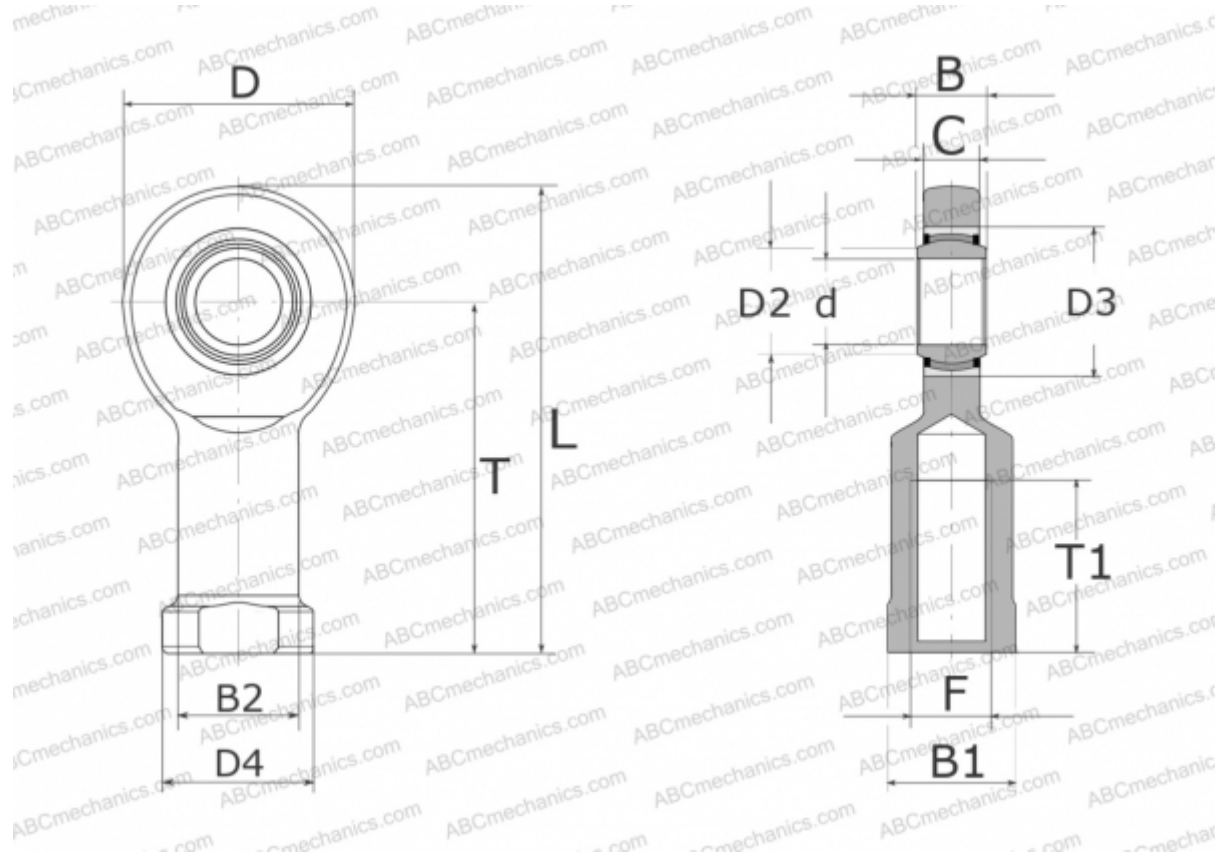

Technical specification

DIMENSIONS, MM

d	35,000
D	82,000
D2	39,800
D3	55,000
D4	58,000
B	25,000
B1	50,000
B2	47,000
L	166,000
T	125,000
T1	60,000
C	21,000
F	M36X3

MANUFACTURER

[INA](#)