

GIR 60 UK 2RS INA

TYPE: Plain bearings, Spherical plain bearings and rod ends, Rod ends, Maintenance free, With internal thread, with lip seals or high performance seals, right hand thread, series GIR..-UK-2RS (INA)

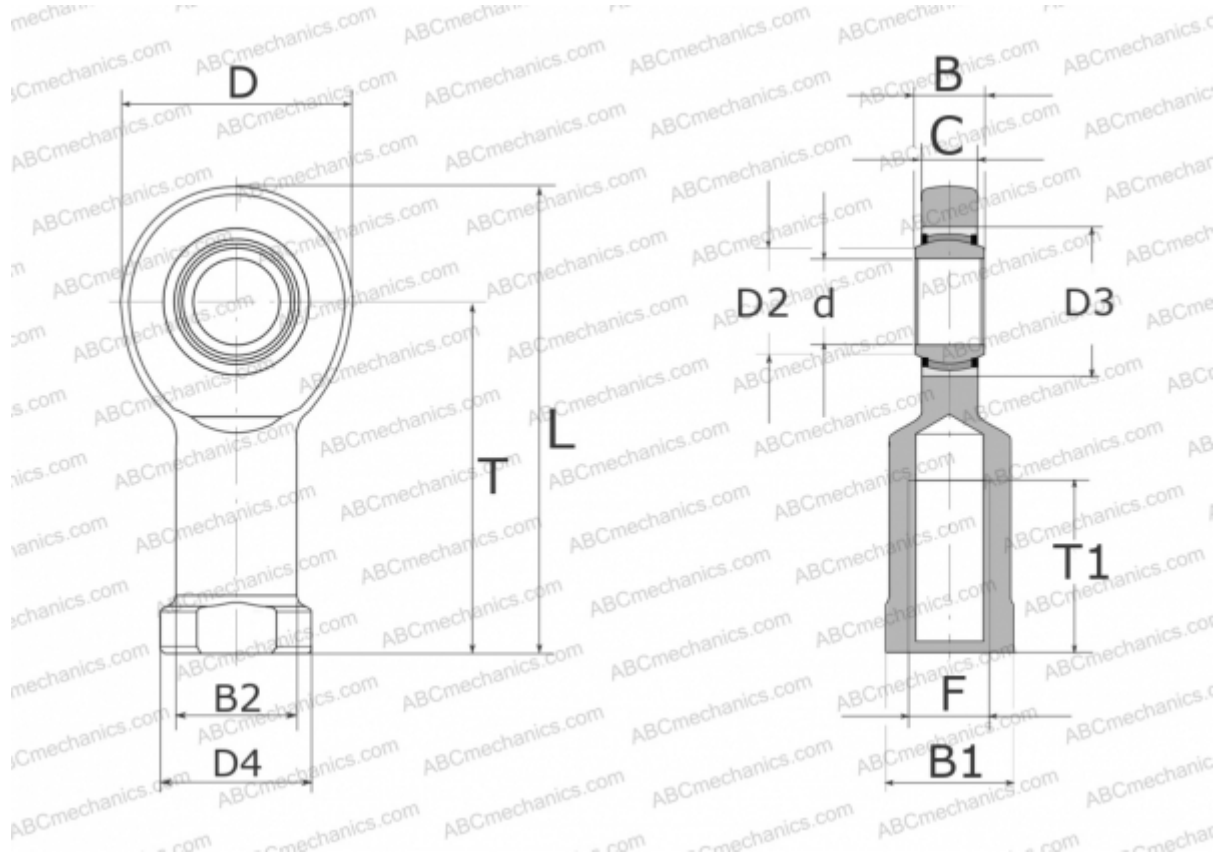

Technical specification

DIMENSIONS, MM

d	60,000
D	135,000
D2	66,800
D3	90,000
D4	88,000
B	44,000
B1	75,000
B2	70,000
L	242,500
T	175,000
T1	70,000
C	38,000
F	M52X3

MANUFACTURER

[INA](#)