

GIL 8 UK INA

TYPE: Plain bearings, Spherical plain bearings and rod ends, Rod ends, Maintenance free, With internal thread, open design, left hand thread, series GIL..-UK (INA)

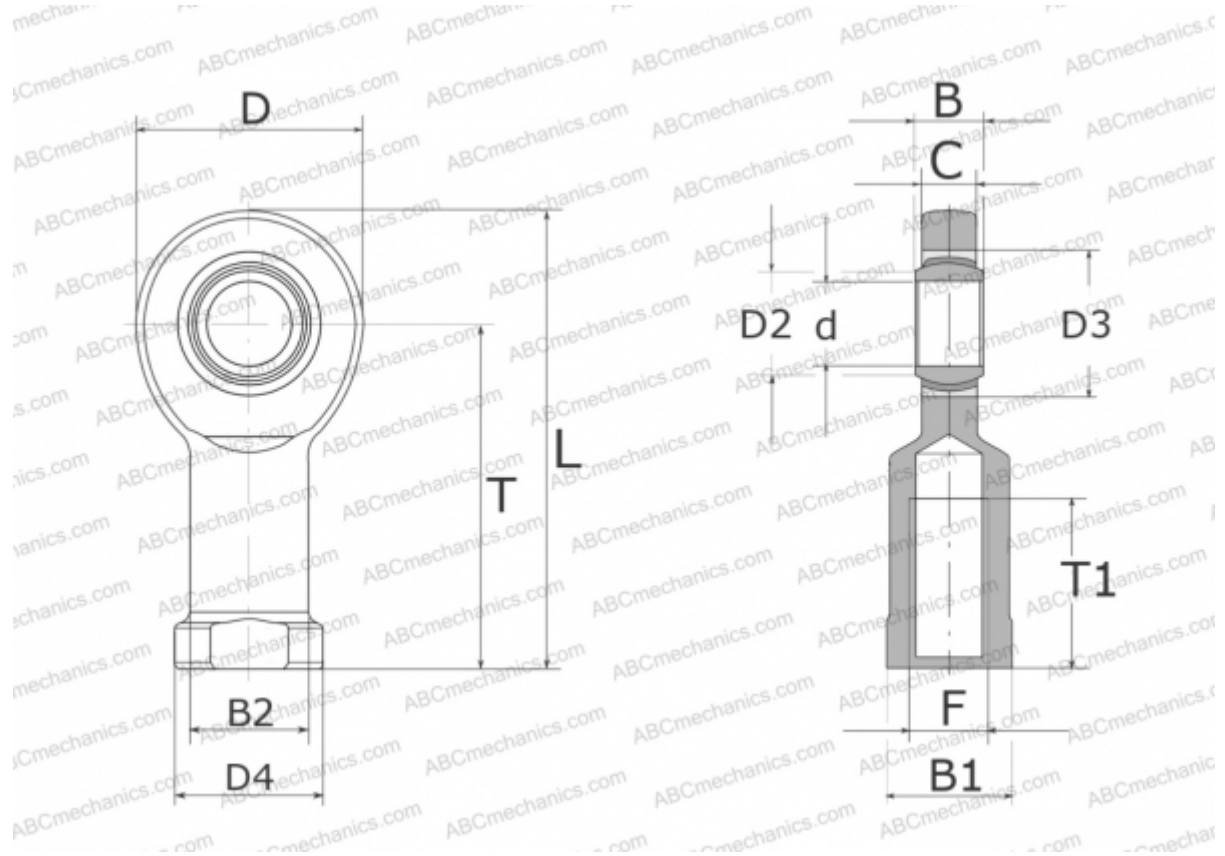

Technical specification

DIMENSIONS, MM

d	8,000
D	24,000
D2	10,200
D3	16,000
D4	16,000
B	8,000
B1	14,000
B2	12,500
L	48,000
T	36,000
T1	15,000
C	6,000
F	M8

MANUFACTURER

[INA](#)