

GIL 12 UK INA

TYPE: Plain bearings, Spherical plain bearings and rod ends, Rod ends, Maintenance free, With internal thread, open design, left hand thread, series GIL..-UK (INA)

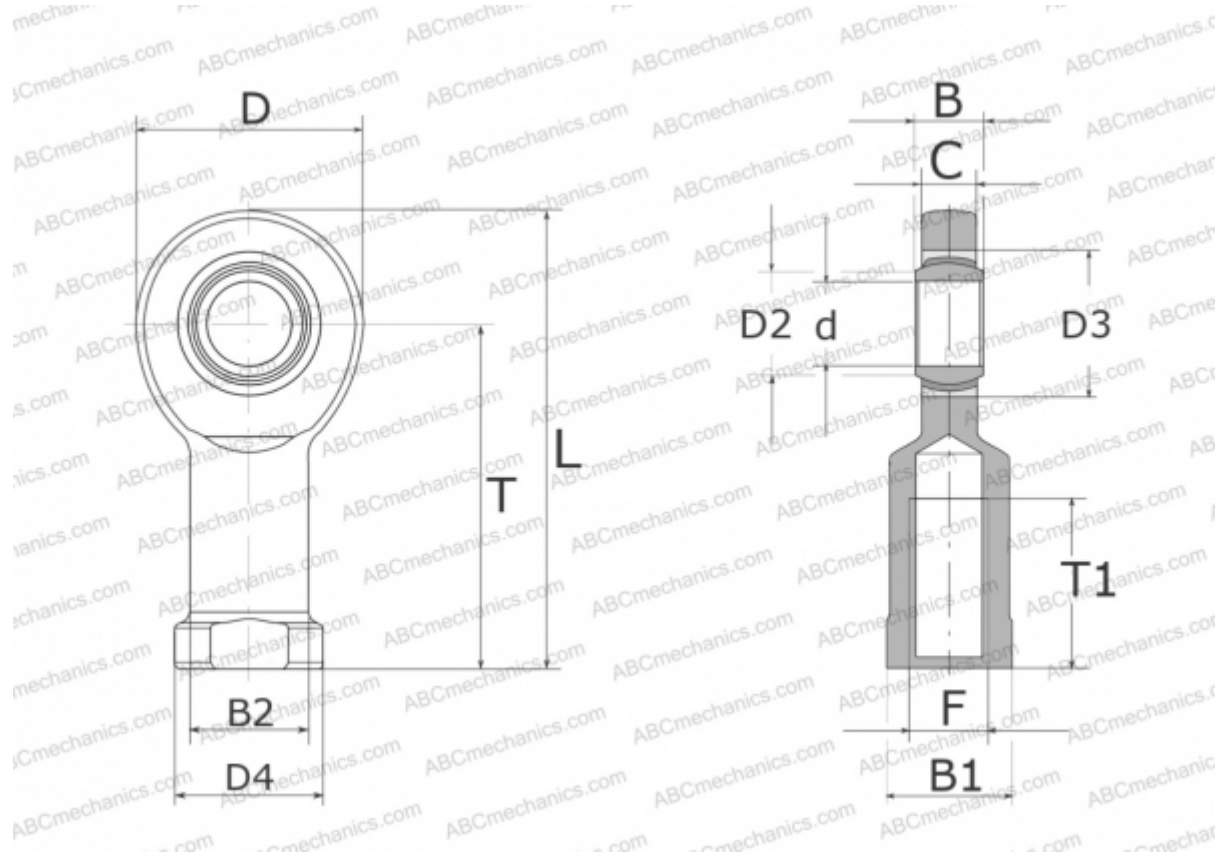

Technical specification

DIMENSIONS, MM

d	12,000
D	34,000
D2	14,900
D3	22,000
D4	22,000
B	10,000
B1	19,000
B2	17,500
L	67,000
T	50,000
T1	23,000
C	8,000
F	M12

MANUFACTURER

[INA](#)