

GIL 40 UK 2RS INA

TYPE: Plain bearings, Spherical plain bearings and rod ends, Rod ends, Maintenance free, With internal thread, with lip seals or high performance seals, left hand thread, series GIL.-UK-2RS (INA)

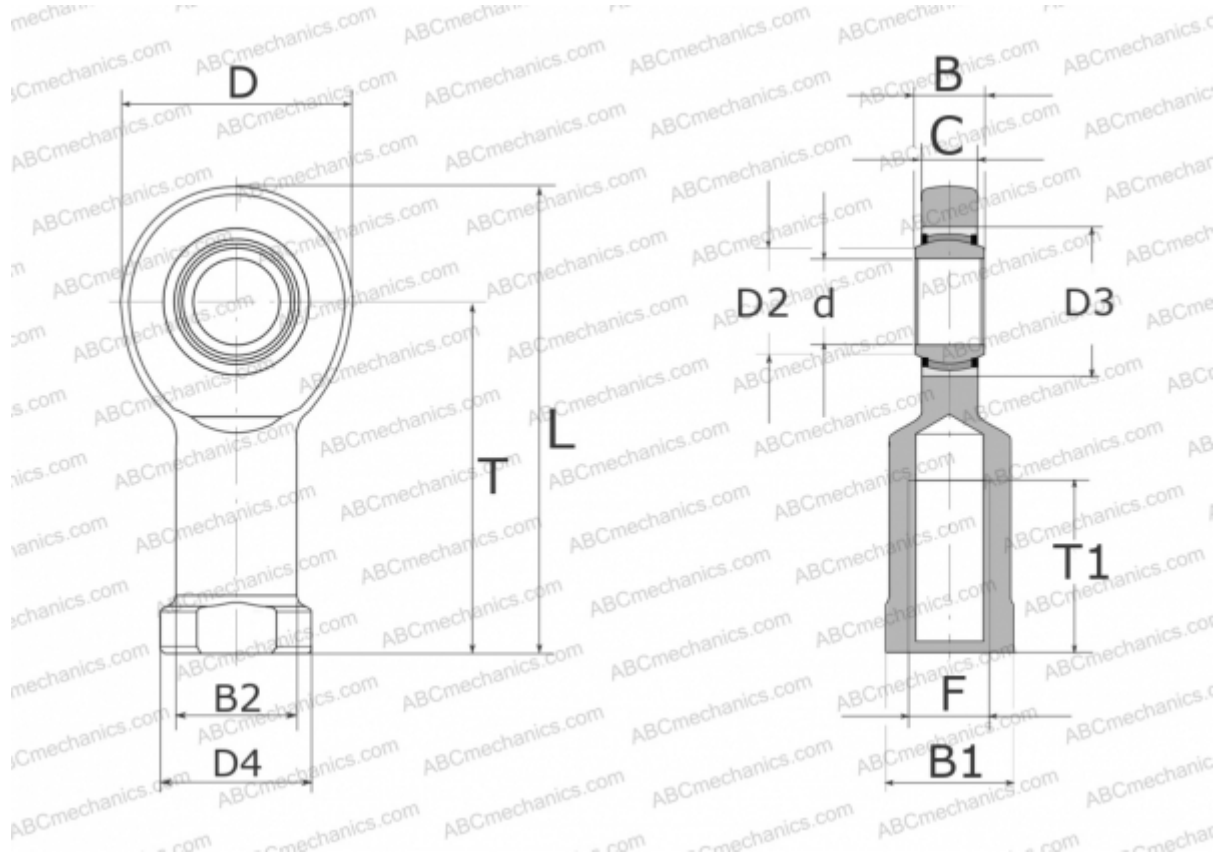

Technical specification

DIMENSIONS, MM

d	40,000
D	92,000
D2	45,000
D3	62,000
D4	65,000
B	28,000
B1	55,000
B2	52,000
L	188,000
T	142,000
T1	65,000
C	23,000
F	M39X3

MANUFACTURER

[INA](#)