

GAR 8 UK INA

TYPE: Plain bearings, Spherical plain bearings and rod ends, Rod ends, Maintenance free, With external thread, open design, right hand thread, series GAR...-UK (INA)

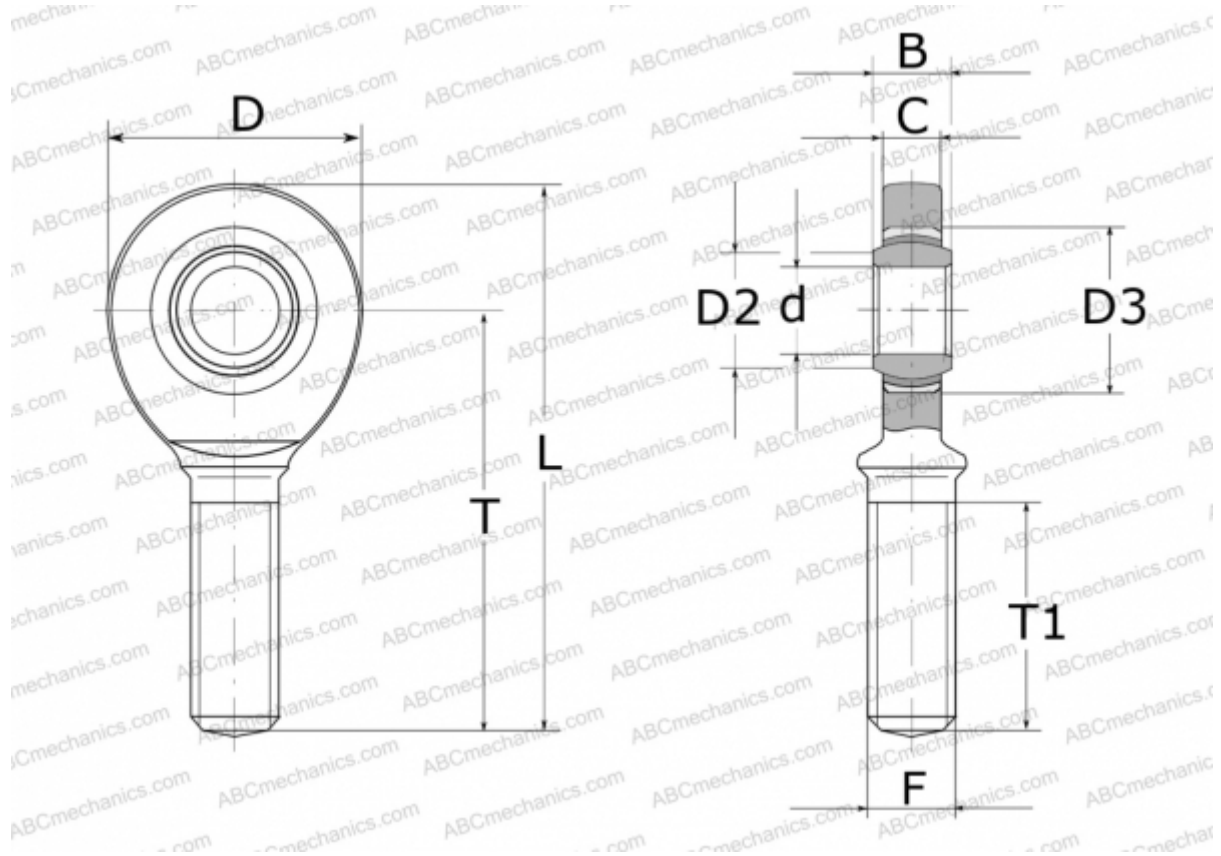

Technical specification

DIMENSIONS, MM

d	8,000
D	24,000
D2	10,200
D3	16,000
B	8,000
L	54,000
T	42,000
T1	22,000
C	6,000
F	M8

MANUFACTURER [INA](#)