

GAR 12 UK INA

TYPE: Plain bearings, Spherical plain bearings and rod ends, Rod ends, Maintenance free, With external thread, open design, right hand thread, series GAR...-UK (INA)

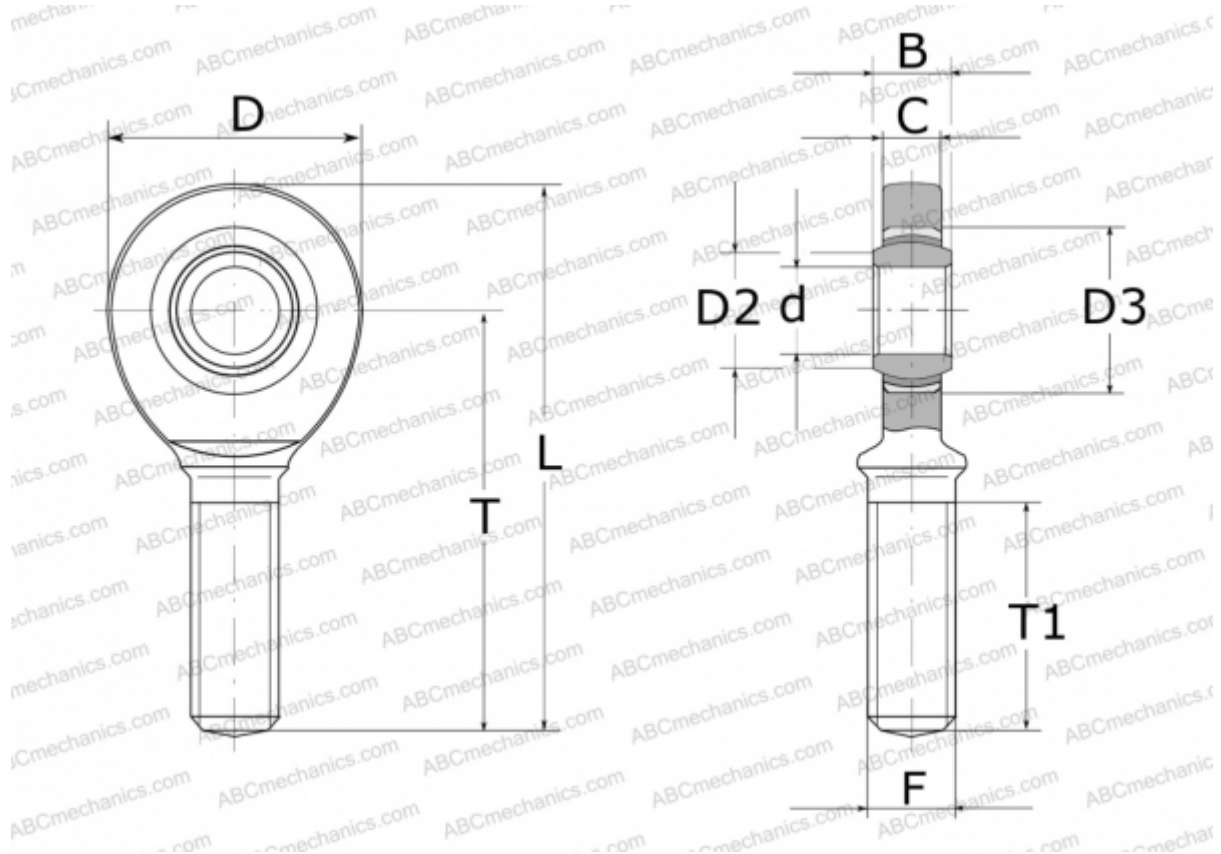

Technical specification

DIMENSIONS, MM

d	12,000
D	34,000
D2	14,900
D3	22,000
B	10,000
L	71,000
T	54,000
T1	28,000
C	8,000
F	M12

MANUFACTURER [INA](#)