

GAR 17 UK INA

TYPE: Plain bearings, Spherical plain bearings and rod ends, Rod ends, Maintenance free, With external thread, open design, right hand thread, series GAR...-UK (INA)

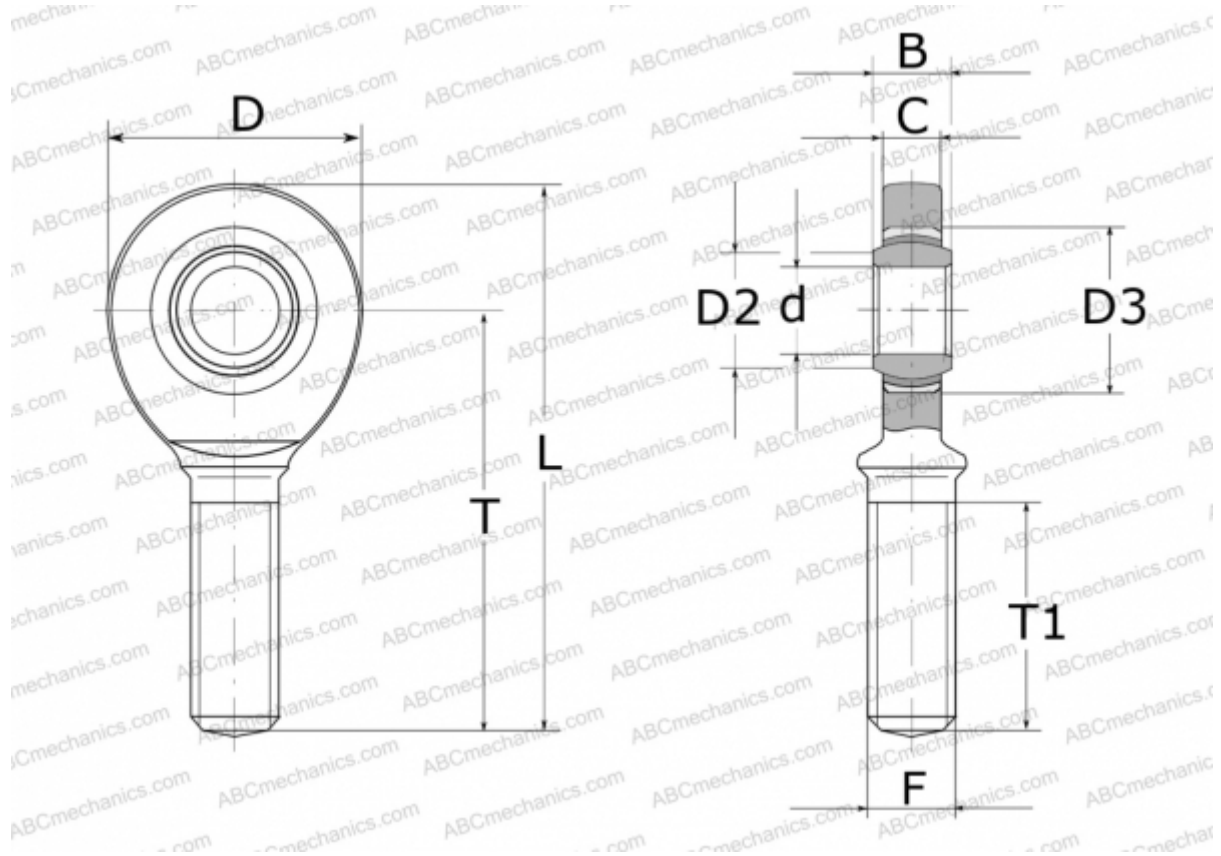

Technical specification

DIMENSIONS, MM

d	17,000
D	46,000
D2	20,700
D3	30,000
B	14,000
L	92,000
T	69,000
T1	36,000
C	11,000
F	M16

MANUFACTURER [INA](#)