

## GAR 40 UK 2RS INA

TYPE: Plain bearings, Spherical plain bearings and rod ends, Rod ends, Maintenance free, With external thread, with lip seals or high performance seals, right hand thread, series GAR..-UK-2RS (INA)

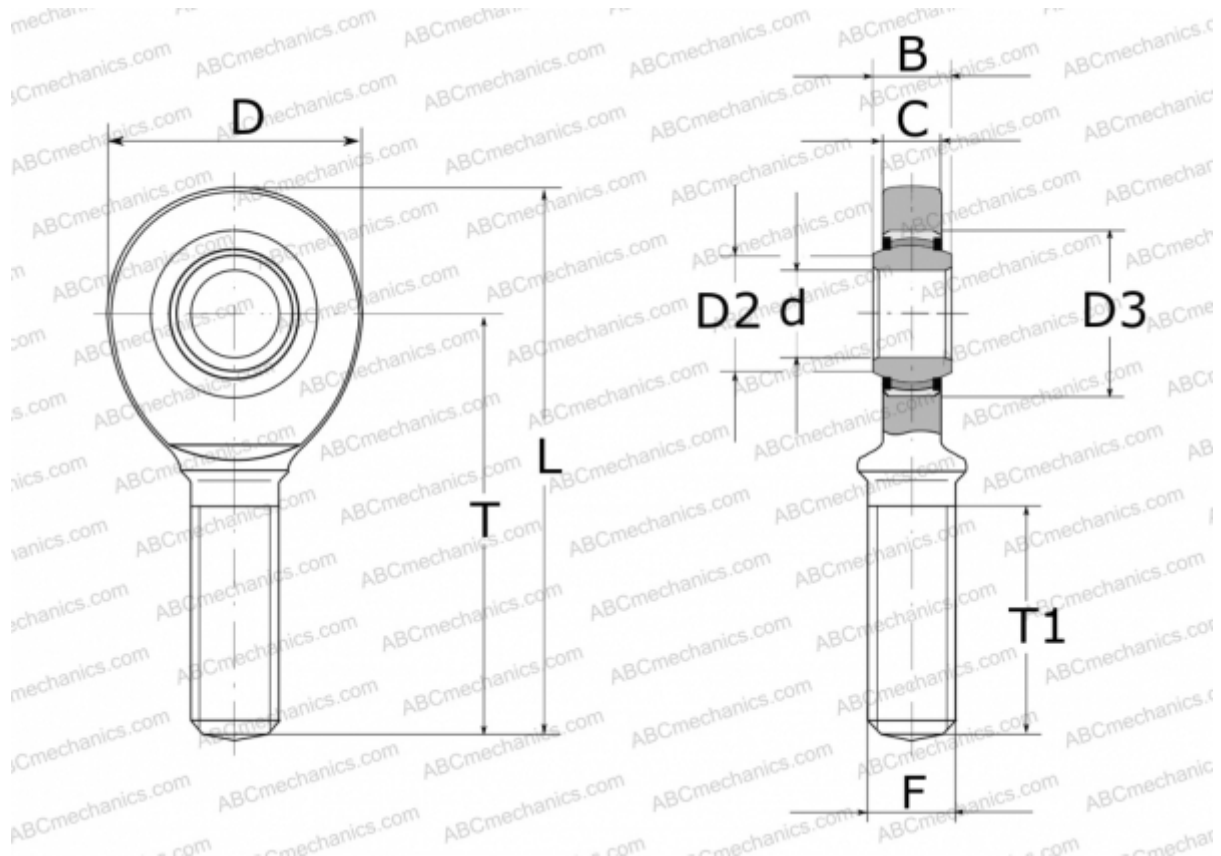

### Technical specification

#### DIMENSIONS, MM

d	40,000
D	92,000
D2	45,000
D3	62,000
B	28,000
L	196,000
T	150,000
T1	86,000
C	23,000
F	M39X3

#### MANUFACTURER

[INA](#)