

GAR 60 UK 2RS INA

TYPE: Plain bearings, Spherical plain bearings and rod ends, Rod ends, Maintenance free, With external thread, with lip seals or high performance seals, right hand thread, series GAR..-UK-2RS (INA)

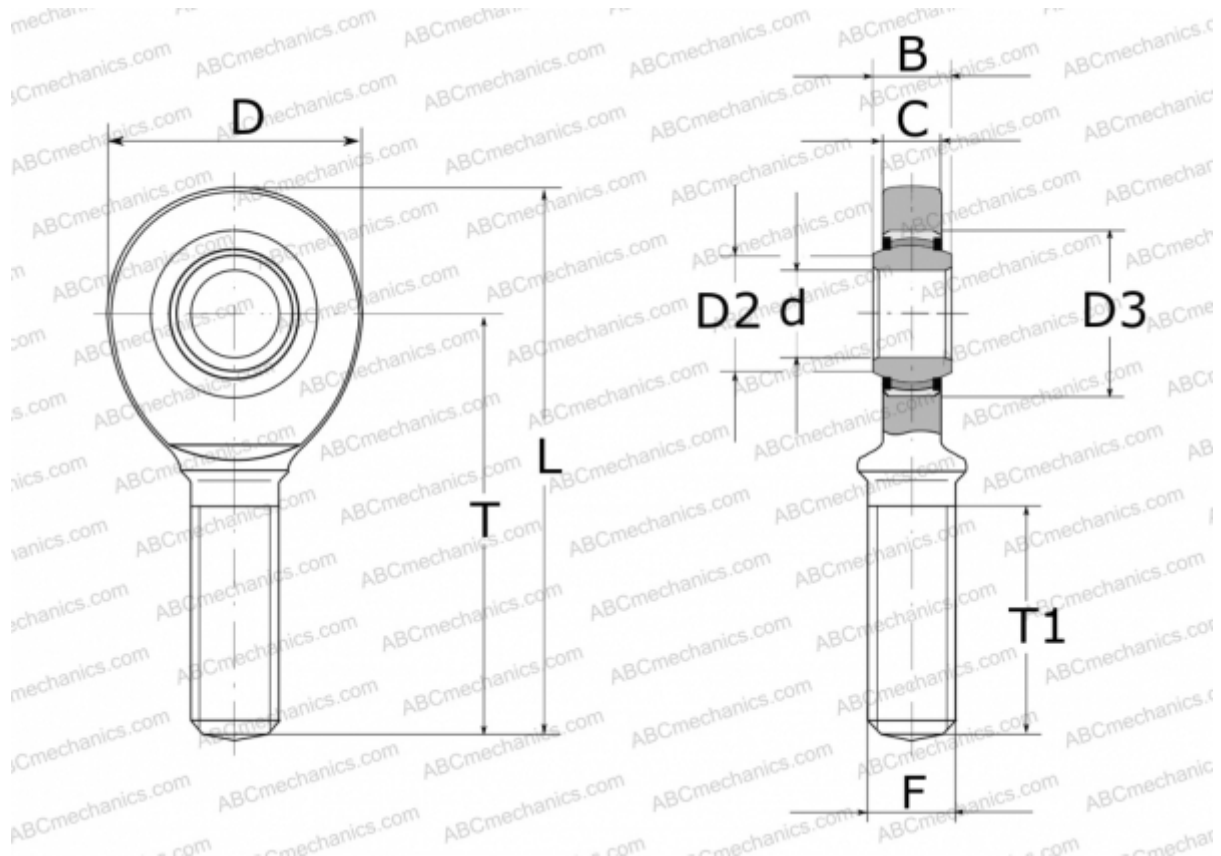

Technical specification

DIMENSIONS, MM

d	60,000
D	135,000
D2	66,800
D3	90,000
B	44,000
L	277,500
T	210,000
T1	115,000
C	38,000
F	M52X3

MANUFACTURER

[INA](#)