

GAKSR 6 PS INA

TYPE: Plain bearings, Spherical plain bearings and rod ends, Rod ends, Maintenance free, With external thread, open design, right hand thread, corrosion-resistant, series GAKSR..-PS (INA)

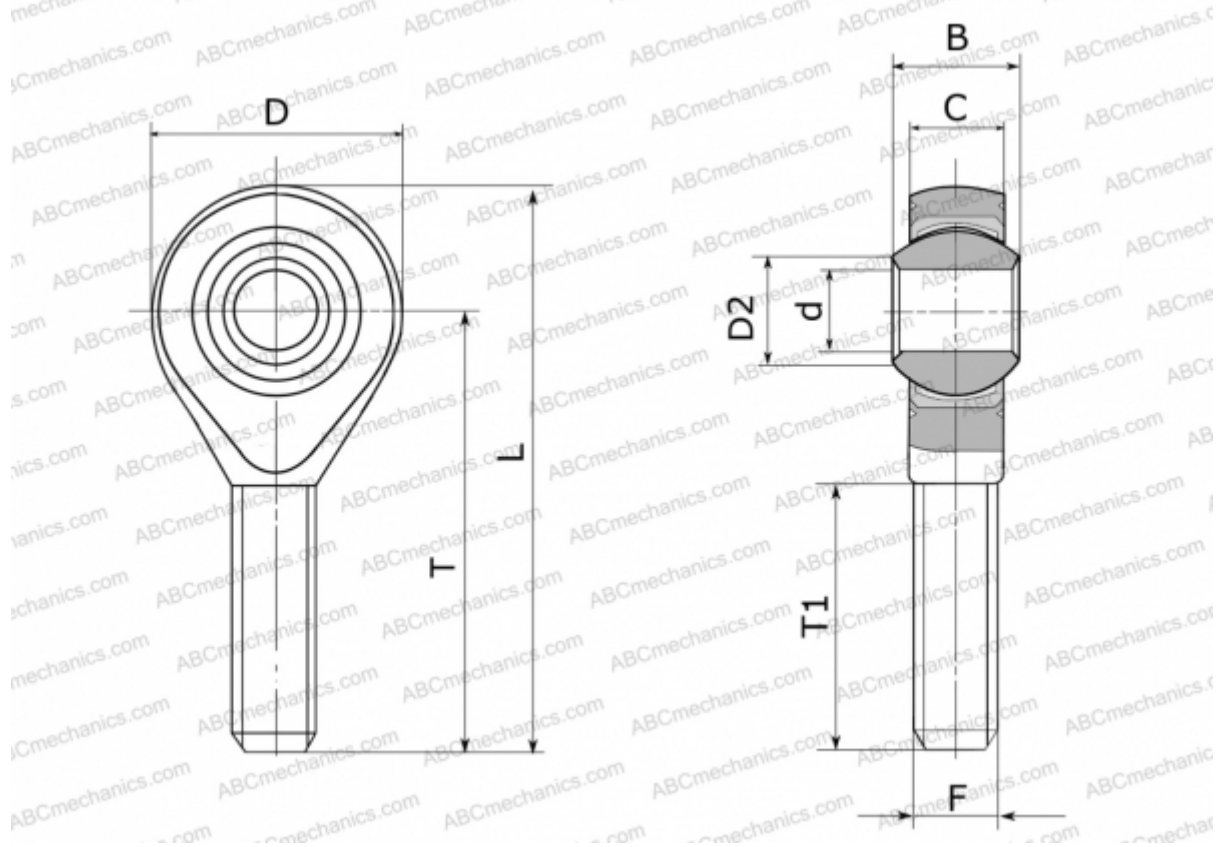

Technical specification

DIMENSIONS, MM

d	6,000
D	21,000
D2	9,000
B	9,000
L	46,500
T	36,000
T1	21,000
C	6,750
F	M6

MANUFACTURER

[INA](#)