

GAKSR 8 PS INA

TYPE: Plain bearings, Spherical plain bearings and rod ends, Rod ends, Maintenance free, With external thread, open design, right hand thread, corrosion-resistant, series GAKSR..-PS (INA)

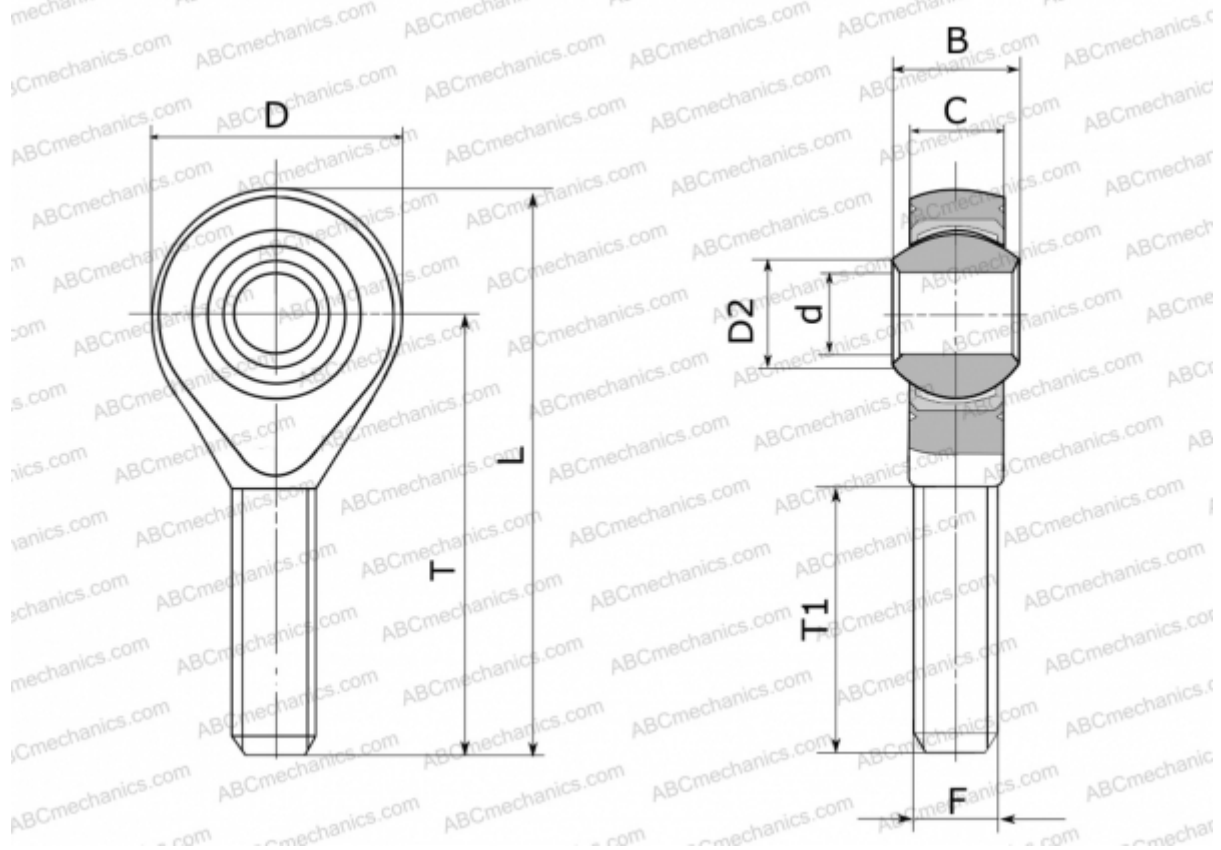

Technical specification

DIMENSIONS, MM

d	8,000
D	25,000
D2	10,400
B	12,000
L	54,500
T	42,000
T1	25,000
C	9,000
F	M8

MANUFACTURER

[INA](#)