

## GAKSR 12 PS INA

TYPE: Plain bearings, Spherical plain bearings and rod ends, Rod ends, Maintenance free, With external thread, open design, right hand thread, corrosion-resistant, series GAKSR..-PS (INA)

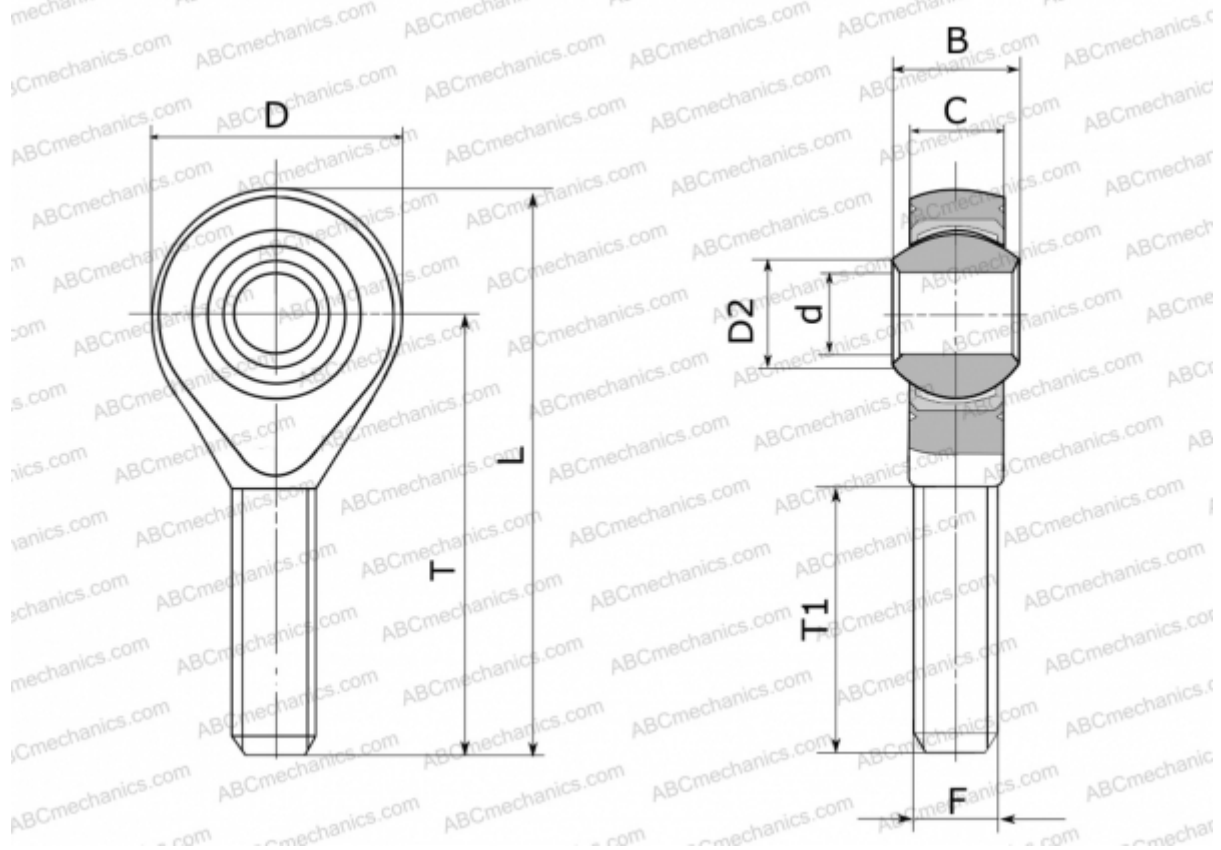

### Technical specification

#### DIMENSIONS, MM

d	12,000
D	33,000
D2	15,400
B	16,000
L	70,500
T	54,000
T1	32,000
C	12,000
F	M12

#### MANUFACTURER

[INA](#)