

GAKSR 16 PS INA

TYPE: Plain bearings, Spherical plain bearings and rod ends, Rod ends, Maintenance free, With external thread, open design, right hand thread, corrosion-resistant, series GAKSR..-PS (INA)

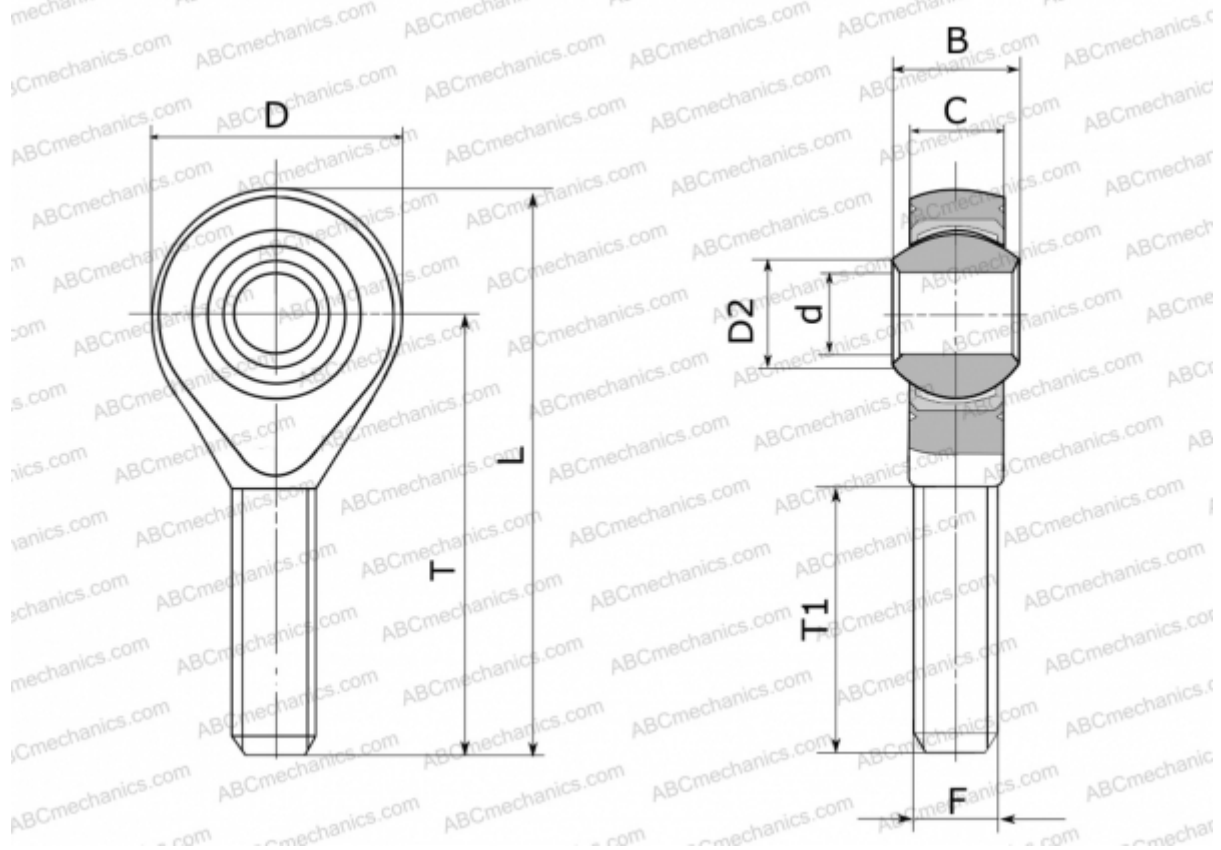

Technical specification

DIMENSIONS, MM

d	16,000
D	43,000
D2	19,400
B	21,000
L	87,500
T	66,000
T1	37,000
C	15,000
F	M16

MANUFACTURER

[INA](#)