

## GAKSR 22 PS INA

TYPE: Plain bearings, Spherical plain bearings and rod ends, Rod ends, Maintenance free, With external thread, open design, right hand thread, corrosion-resistant, series GAKSR..-PS (INA)

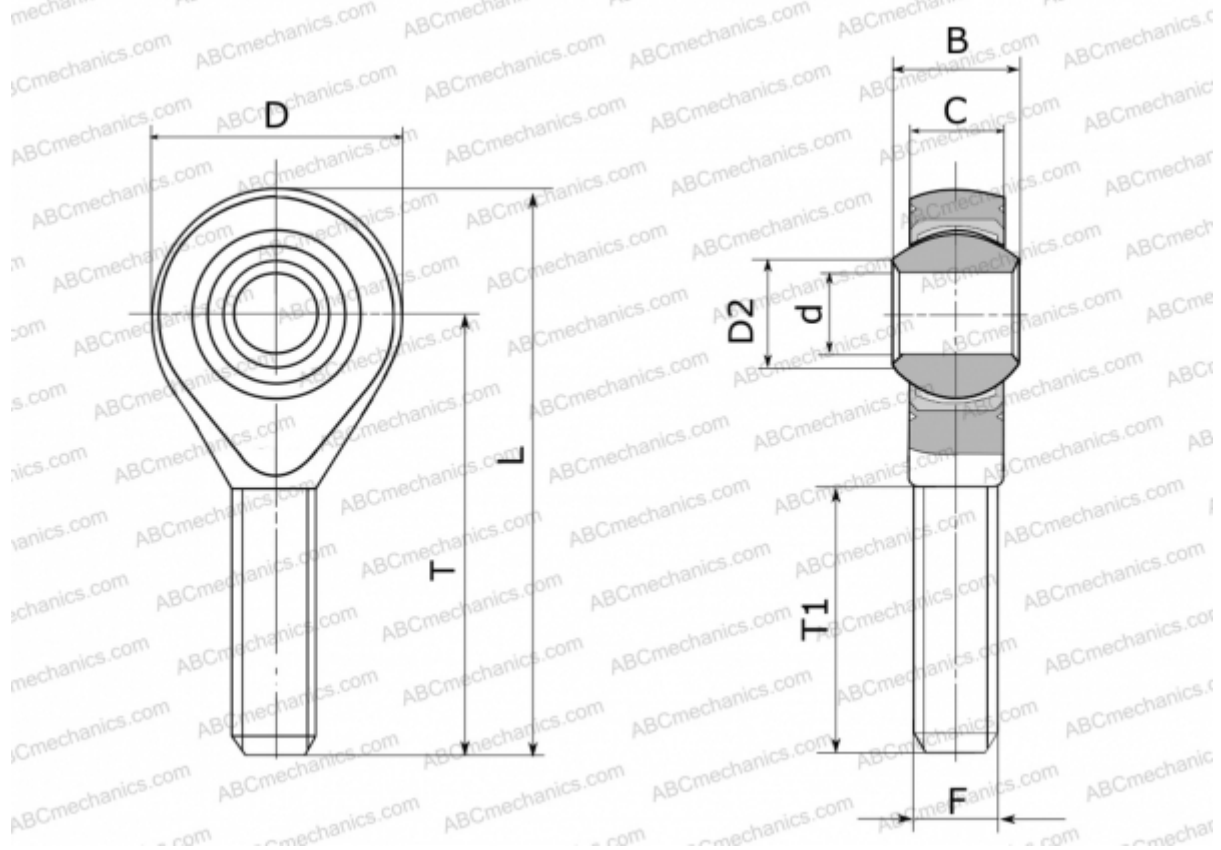

### Technical specification

#### DIMENSIONS, MM

d	22,000
D	55,000
D2	25,800
B	28,000
L	112,000
T	84,000
T1	48,000
C	20,000
F	M22X1.5

#### MANUFACTURER

[INA](#)