

GIKSR 8 PS INA

TYPE: Plain bearings, Spherical plain bearings and rod ends, Rod ends, Maintenance free, With internal thread, corrosion-resistant, open design, right hand thread, series GIKSR..-PS, GIKPSR..-PS (INA)

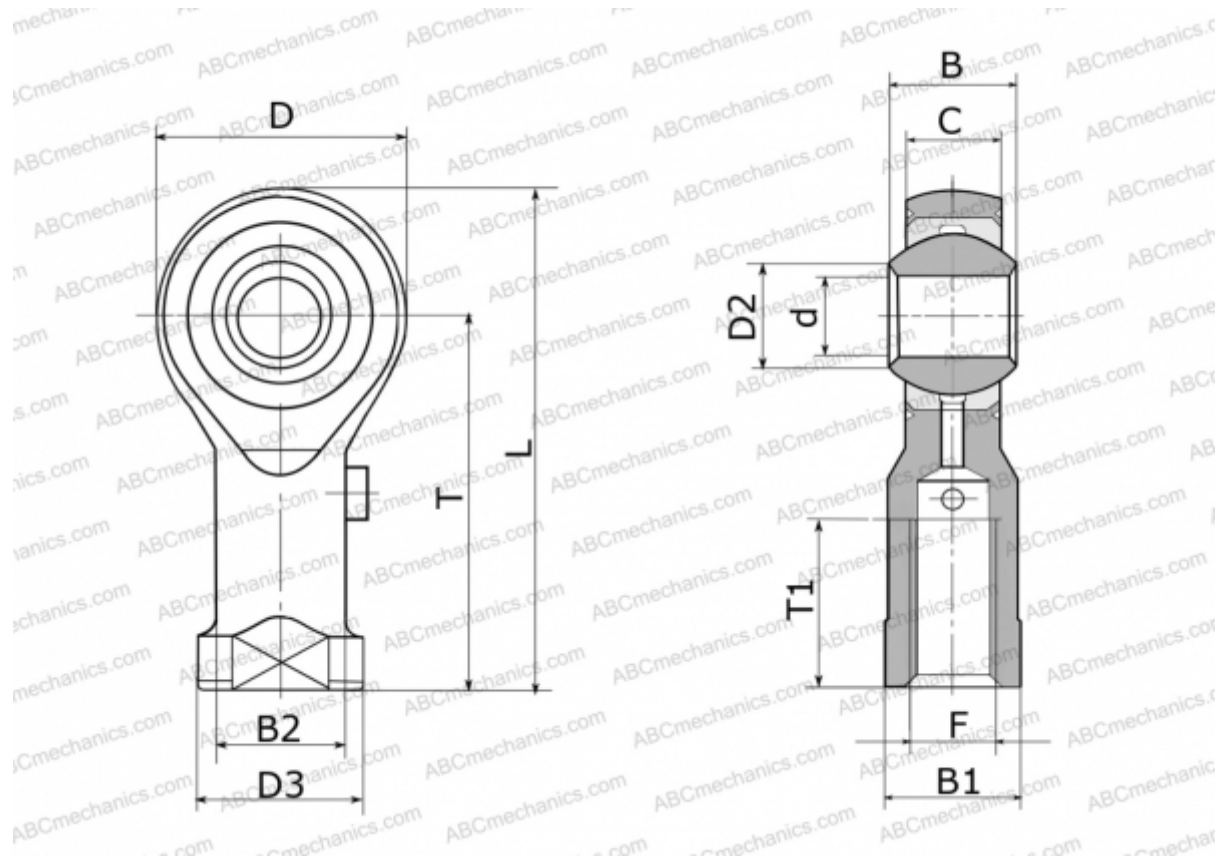

Technical specification

DIMENSIONS, MM

d	8,000
D	25,000
D2	10,400
D3	16,000
B	12,000
B1	14,000
B2	12,500
L	48,500
T	36,000
T1	12,000
C	9,000
F	M8

MANUFACTURER

[INA](#)