

GIKSR 12 PS INA

TYPE: Plain bearings, Spherical plain bearings and rod ends, Rod ends, Maintenance free, With internal thread, corrosion-resistant, open design, right hand thread, series GIKSR..-PS, GIKPSR..-PS (INA)

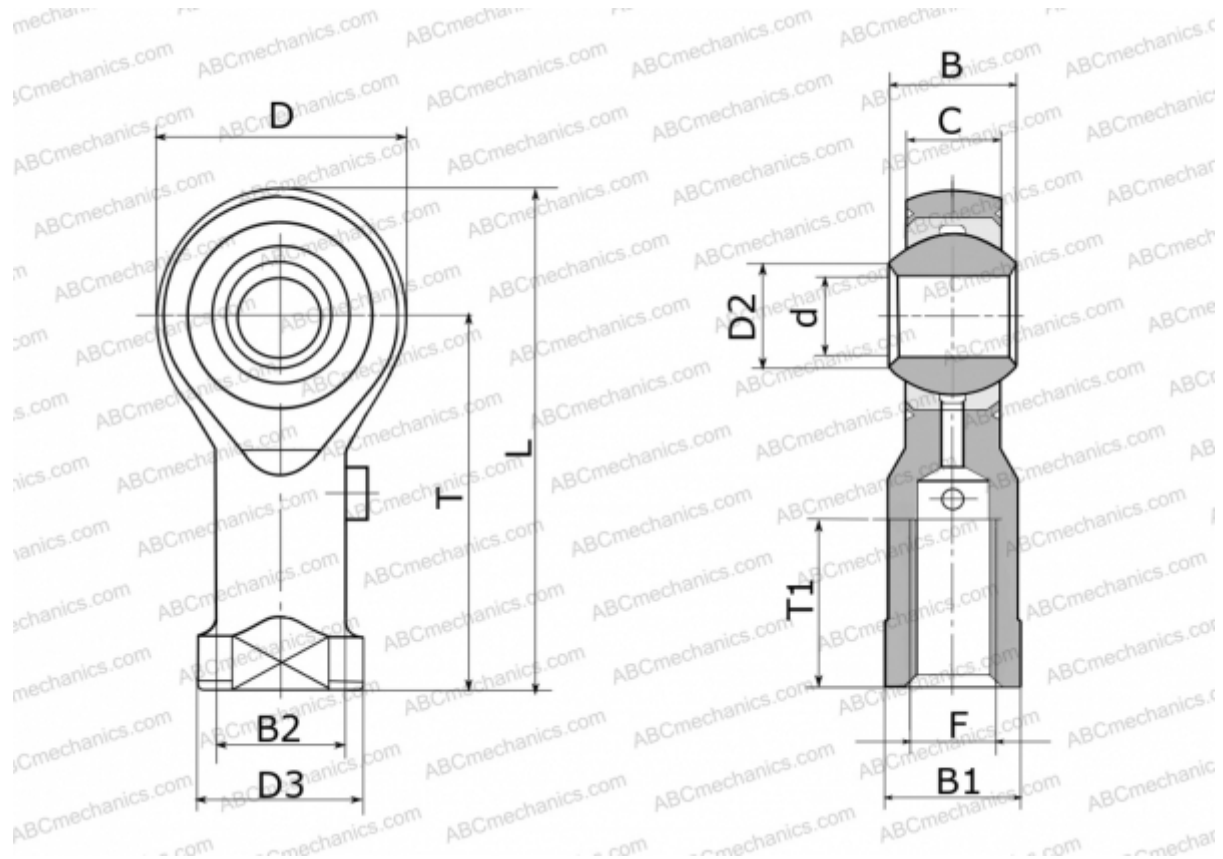

Technical specification

DIMENSIONS, MM

d	12,000
D	33,000
D2	15,400
D3	22,000
B	16,000
B1	19,000
B2	17,500
L	66,500
T	50,000
T1	18,000
C	12,000
F	M12

MANUFACTURER

[INA](#)