

## GIKSL 6 PS INA

TYPE: Plain bearings, Spherical plain bearings and rod ends, Rod ends, Maintenance free, With internal thread, corrosion-resistant, open design, left hand thread, series GIKSL..-PS, GIKPSL..-PS (INA)

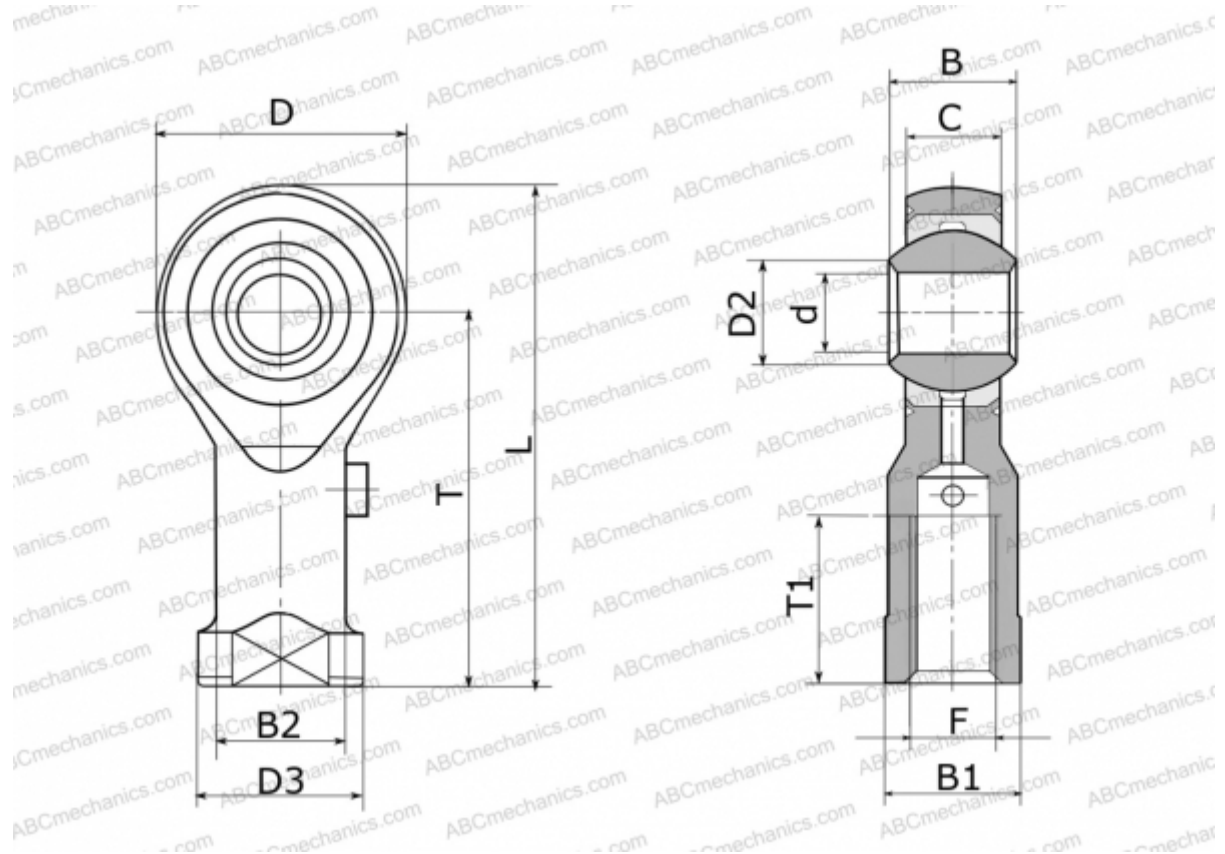

### Technical specification

#### DIMENSIONS, MM

d	6,000
D	21,000
D2	9,000
D3	13,000
B	9,000
B1	11,000
B2	10,000
L	40,500
T	30,000
T1	9,000
C	6,750
F	M6

#### MANUFACTURER

[INA](#)