

GIKSL 14 PS INA

TYPE: Plain bearings, Spherical plain bearings and rod ends, Rod ends, Maintenance free, With internal thread, corrosion-resistant, open design, left hand thread, series GIKSL..-PS, GIKPSL..-PS (INA)

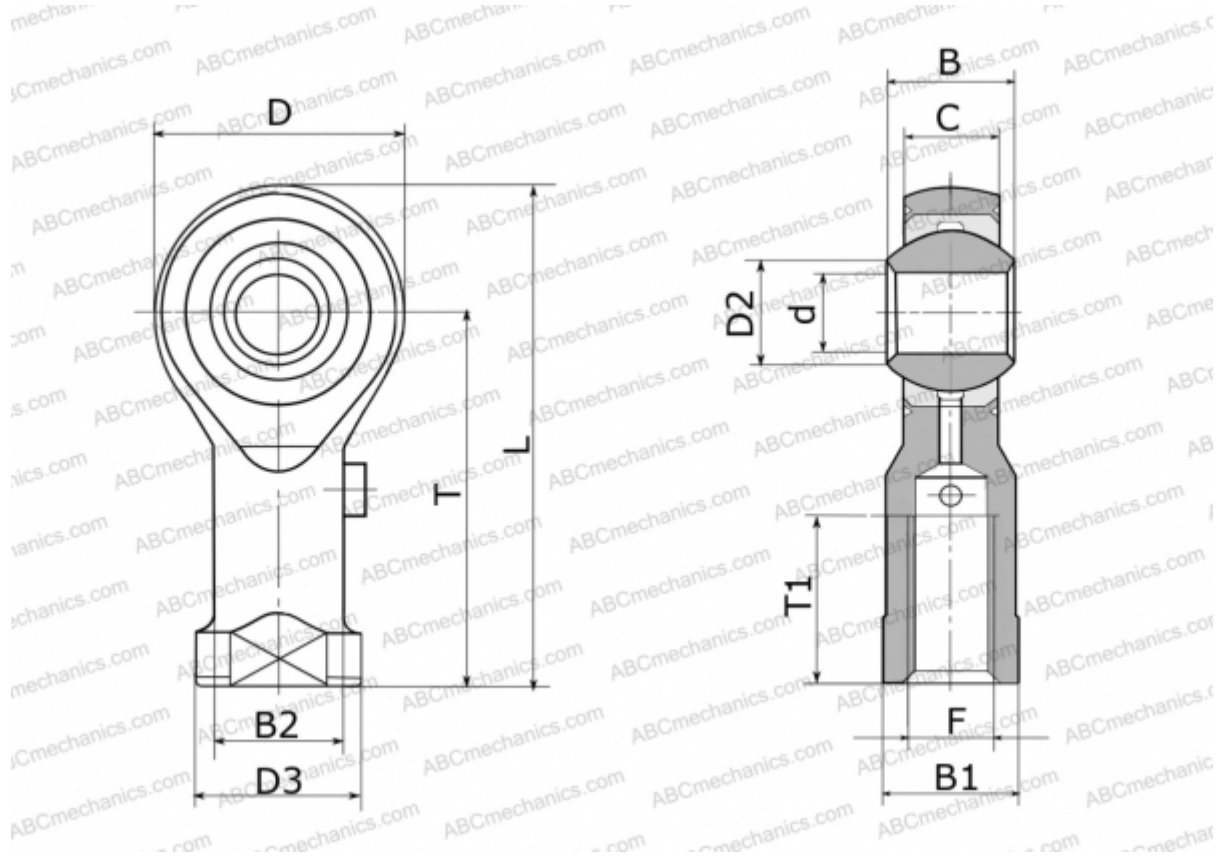

Technical specification

DIMENSIONS, MM

d	14,000
D	37,000
D2	16,800
D3	25,000
B	19,000
B1	22,000
B2	20,000
L	75,500
T	57,000
T1	21,000
C	13,500
F	M14

MANUFACTURER

[INA](#)