

GIKSL 16 PS INA

TYPE: Plain bearings, Spherical plain bearings and rod ends, Rod ends, Maintenance free, With internal thread, corrosion-resistant, open design, left hand thread, series GIKSL..-PS, GIKPSL..-PS (INA)

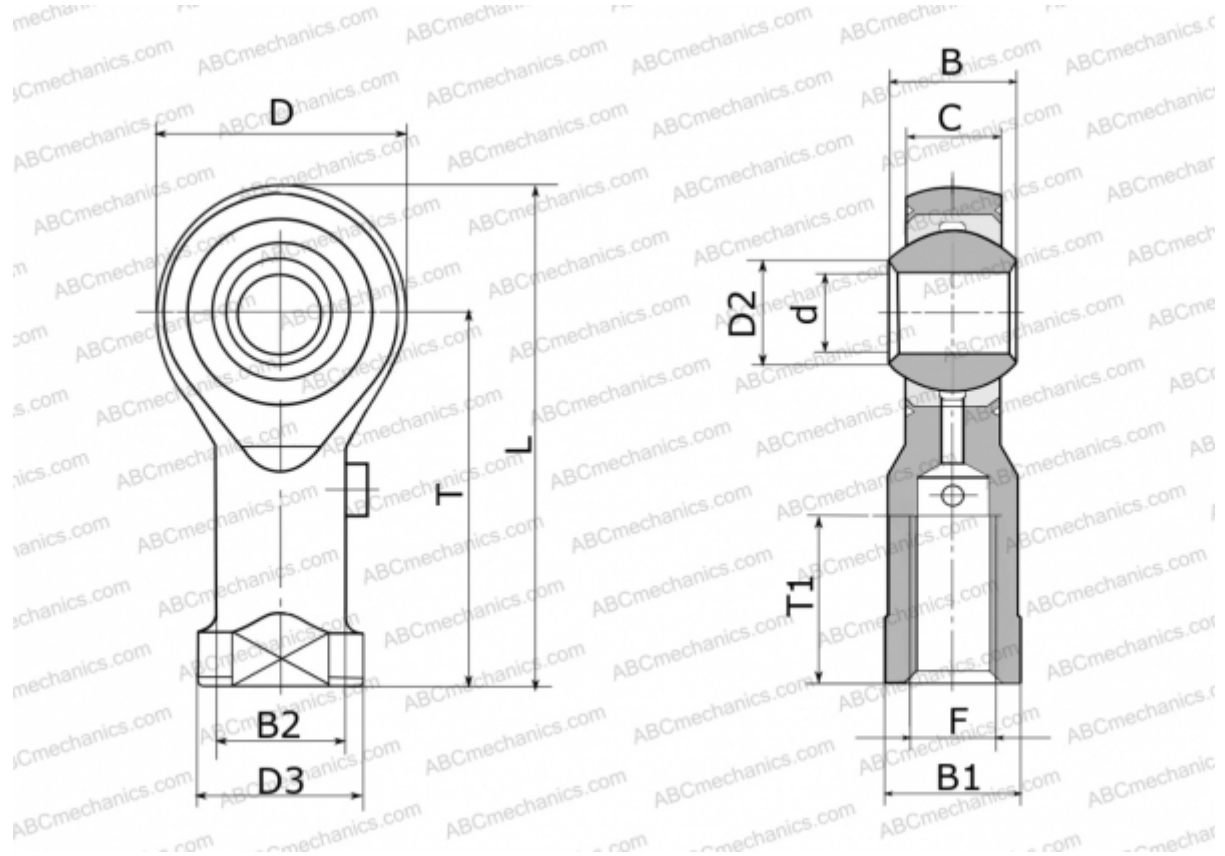

Technical specification

DIMENSIONS, MM

d	16,000
D	43,000
D2	19,400
D3	27,000
B	21,000
B1	22,000
B2	22,000
L	85,500
T	64,000
T1	24,000
C	15,000
F	M16

MANUFACTURER

[INA](#)