

GIL 8 DO INA

TYPE: Plain bearings, Spherical plain bearings and rod ends, Rod ends, Requiring maintenance, With internal thread, open design, left hand thread, series GIL..-DO (INA)

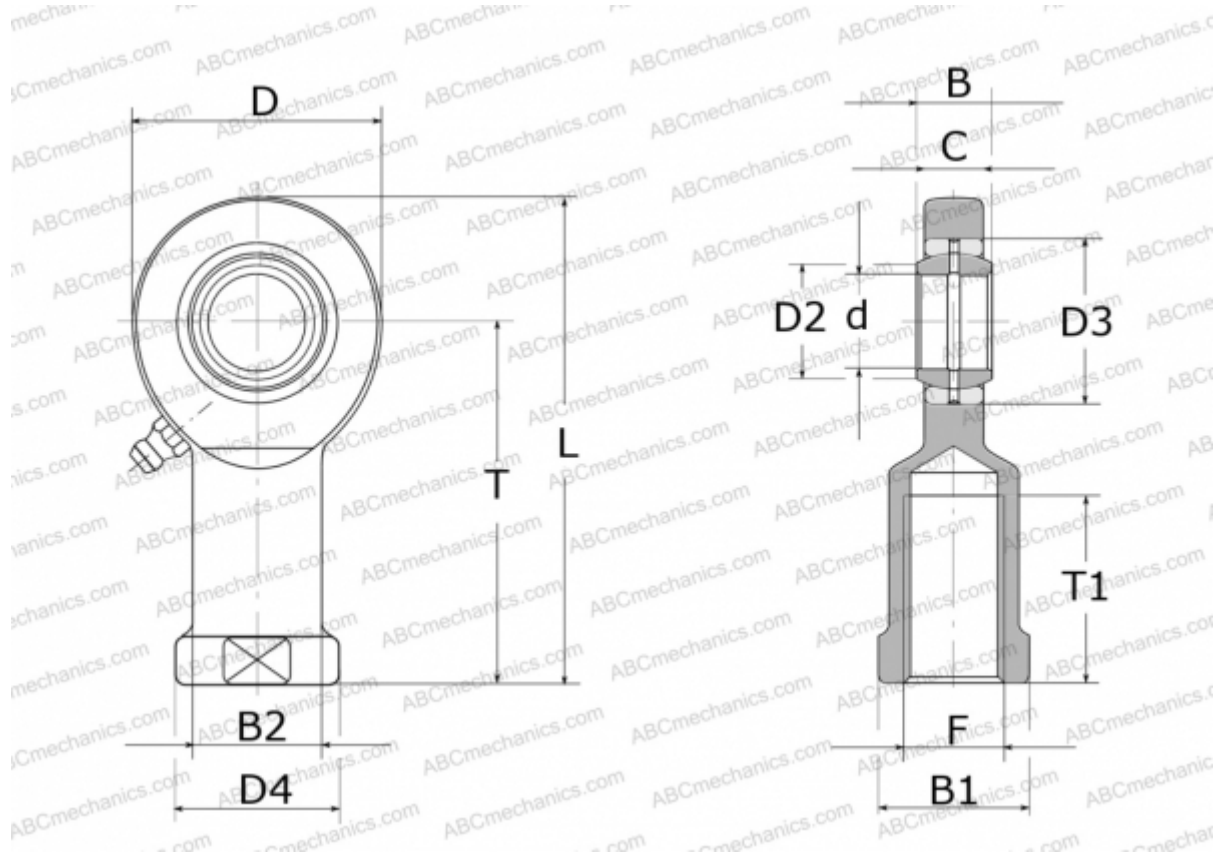

Technical specification

DIMENSIONS, MM

| | |
|----|--------|
| d | 8,000 |
| D | 24,000 |
| D2 | 10,200 |
| D3 | 16,000 |
| D4 | 16,000 |
| B | 8,000 |
| B1 | 14,000 |
| B2 | 12,500 |
| L | 48,000 |
| T | 36,000 |
| T1 | 15,000 |
| C | 6,000 |
| F | M8 |

MANUFACTURER

[INA](#)