

GIL 10 DO INA

TYPE: Plain bearings, Spherical plain bearings and rod ends, Rod ends, Requiring maintenance, With internal thread, open design, left hand thread, series GIL..-DO (INA)

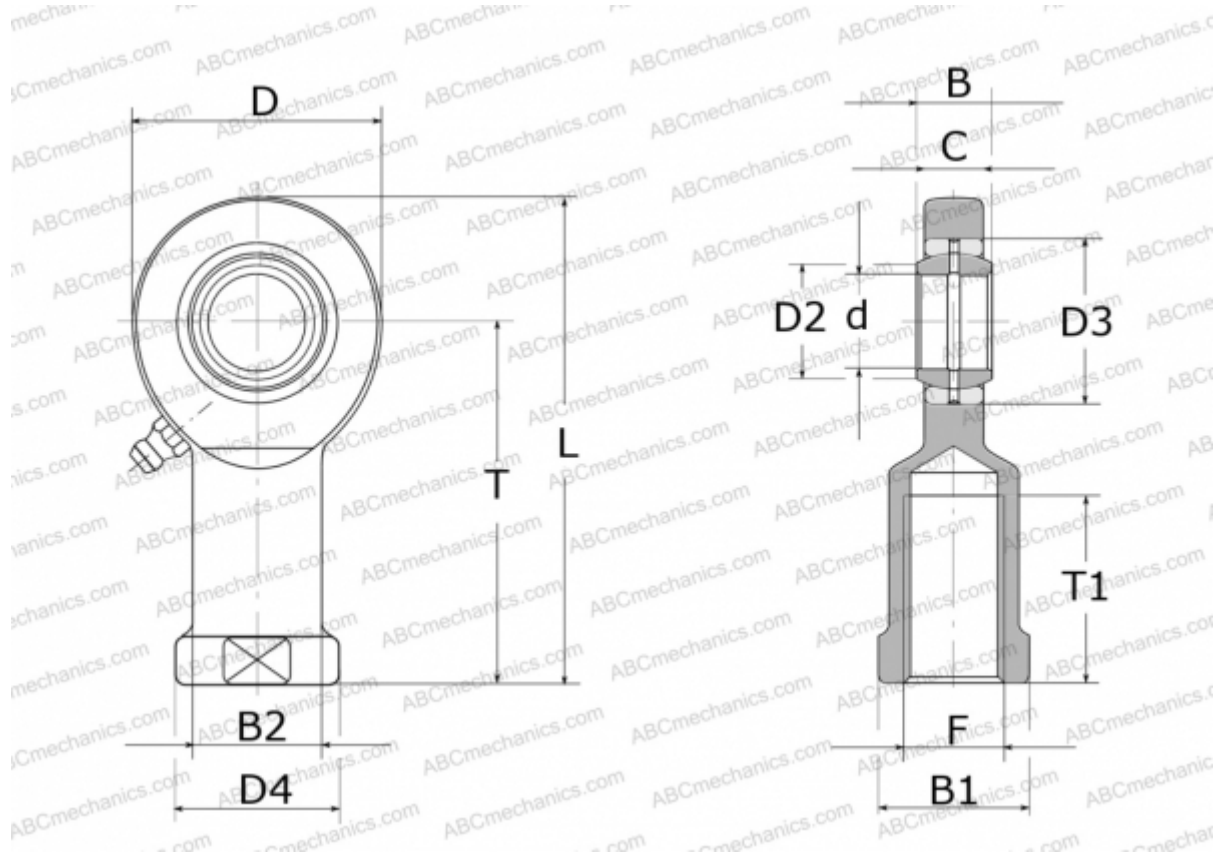

Technical specification

DIMENSIONS, MM

d	10,000
D	29,000
D2	13,200
D3	19,000
D4	19,000
B	9,000
B1	17,000
B2	15,000
L	57,500
T	43,000
T1	20,000
C	7,000
F	M10

MANUFACTURER

[INA](#)