

## GAR 8 DO INA

TYPE: Plain bearings, Spherical plain bearings and rod ends, Rod ends, Requiring maintenance, With external thread, open design, right hand thread, series GAR...-DO (INA)

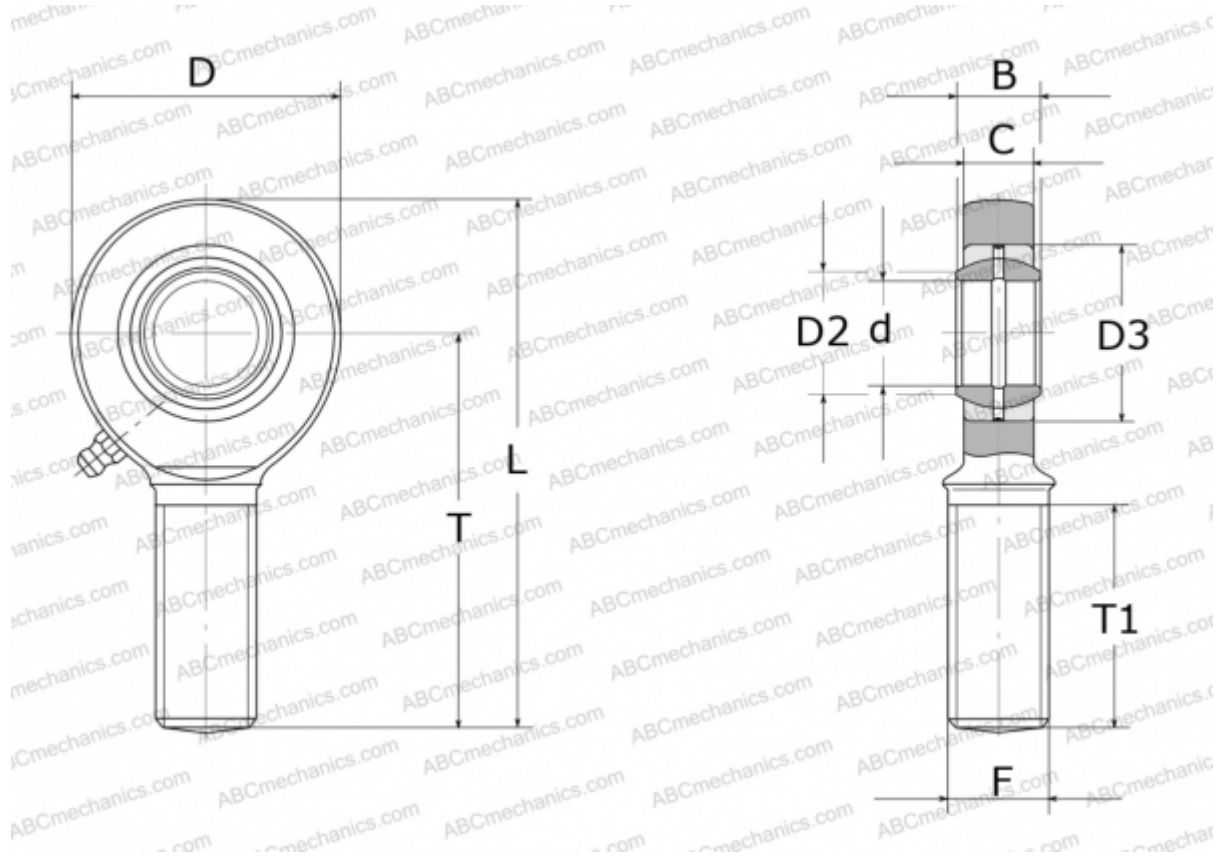

### Technical specification

#### DIMENSIONS, MM

d	8,000
D	24,000
D2	10,200
D3	16,000
B	8,000
L	54,000
T	42,000
T1	22,000
C	6,000
F	M8

**MANUFACTURER** [INA](#)