

## GAR 10 DO INA

TYPE: Plain bearings, Spherical plain bearings and rod ends, Rod ends, Requiring maintenance, With external thread, open design, right hand thread, series GAR...-DO (INA)

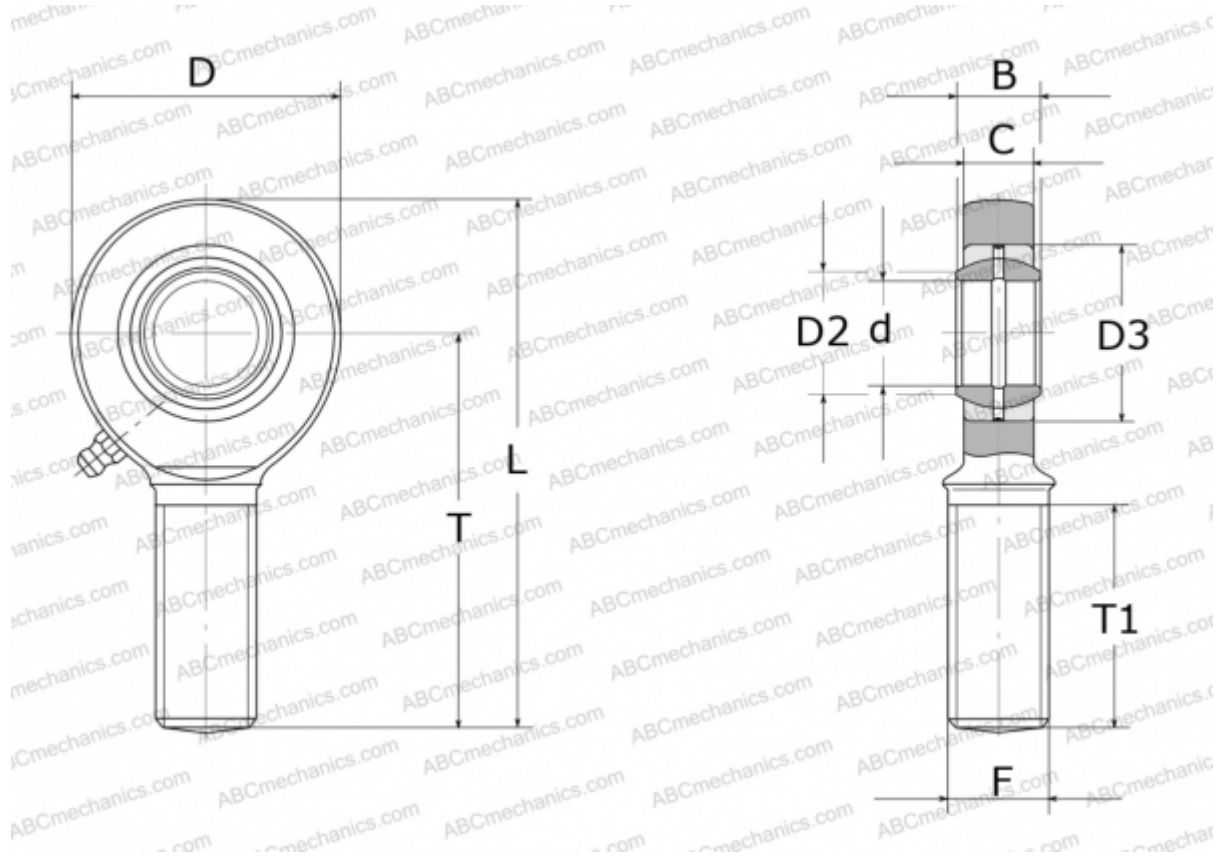

### Technical specification

#### DIMENSIONS, MM

d	10,000
D	29,000
D2	13,200
D3	19,000
B	9,000
L	62,500
T	48,000
T1	26,000
C	7,000
F	M10

**MANUFACTURER** [INA](#)