

GAR 45 DO 2RS INA

TYPE: Plain bearings, Spherical plain bearings and rod ends, Rod ends, Requiring maintenance, With external thread, with lip seals or high performance seals, right hand thread, series GAR..-DO-2RS (INA)

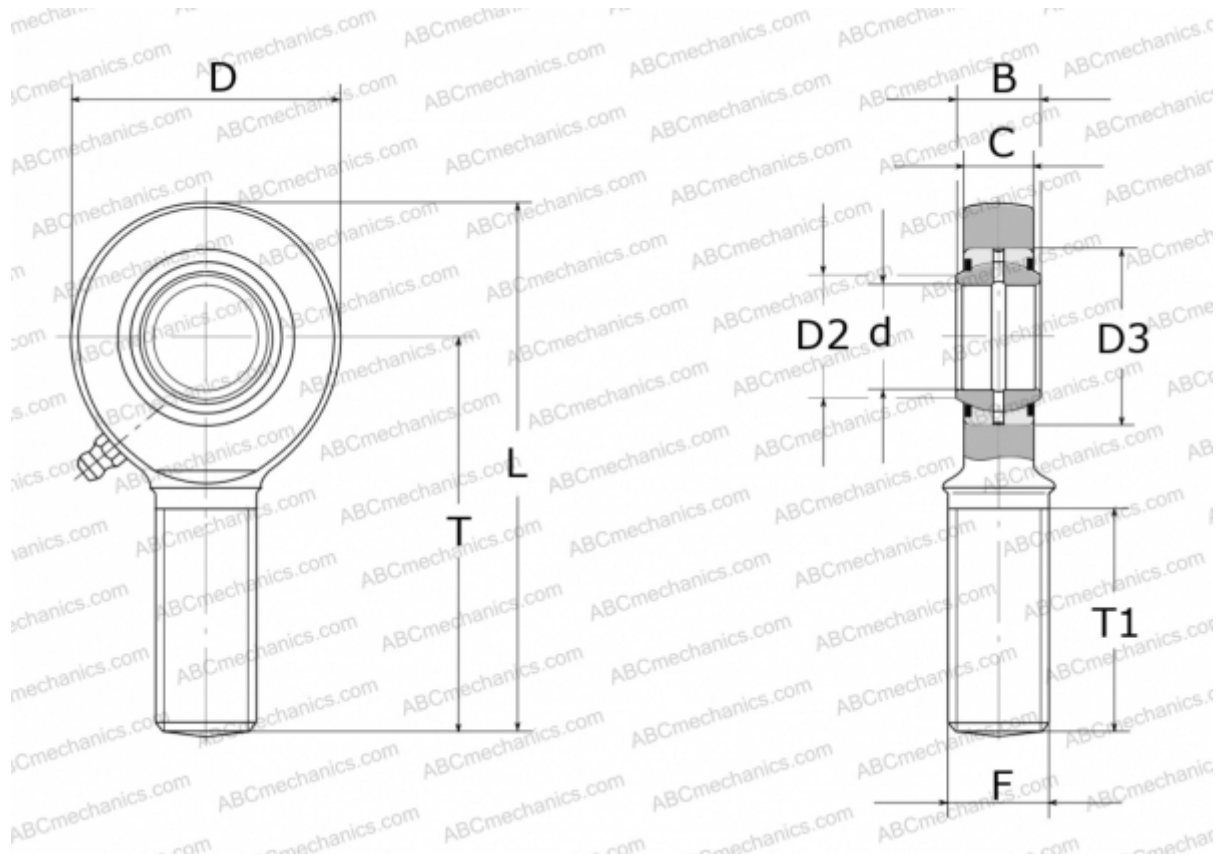

Technical specification

DIMENSIONS, MM

d	45,000
D	102,000
D2	50,800
D3	68,000
B	32,000
L	214,000
T	163,000
T1	94,000
C	27,000
F	M42X3

MANUFACTURER

[INA](#)