

GAR 50 DO 2RS INA

TYPE: Plain bearings, Spherical plain bearings and rod ends, Rod ends, Requiring maintenance, With external thread, with lip seals or high performance seals, right hand thread, series GAR..-DO-2RS (INA)

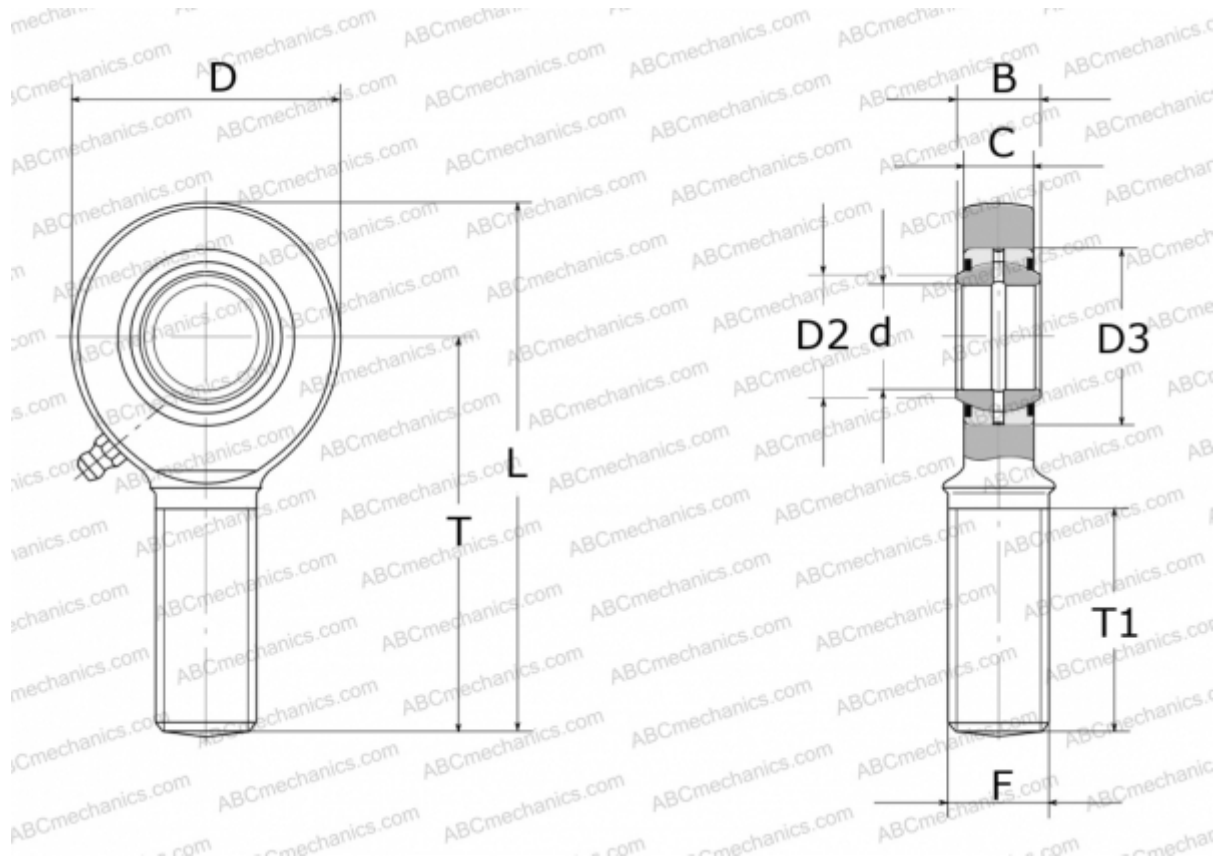

Technical specification

DIMENSIONS, MM

d	50,000
D	112,000
D2	56,000
D3	75,000
B	35,000
L	241,000
T	185,000
T1	107,000
C	30,000
F	M45X3

MANUFACTURER

[INA](#)