

GAL 35 DO 2RS INA

TYPE: Plain bearings, Spherical plain bearings and rod ends, Rod ends, Requiring maintenance, With external thread, with lip seals or high performance seals, left hand thread, series GAL..-DO-2RS (INA)

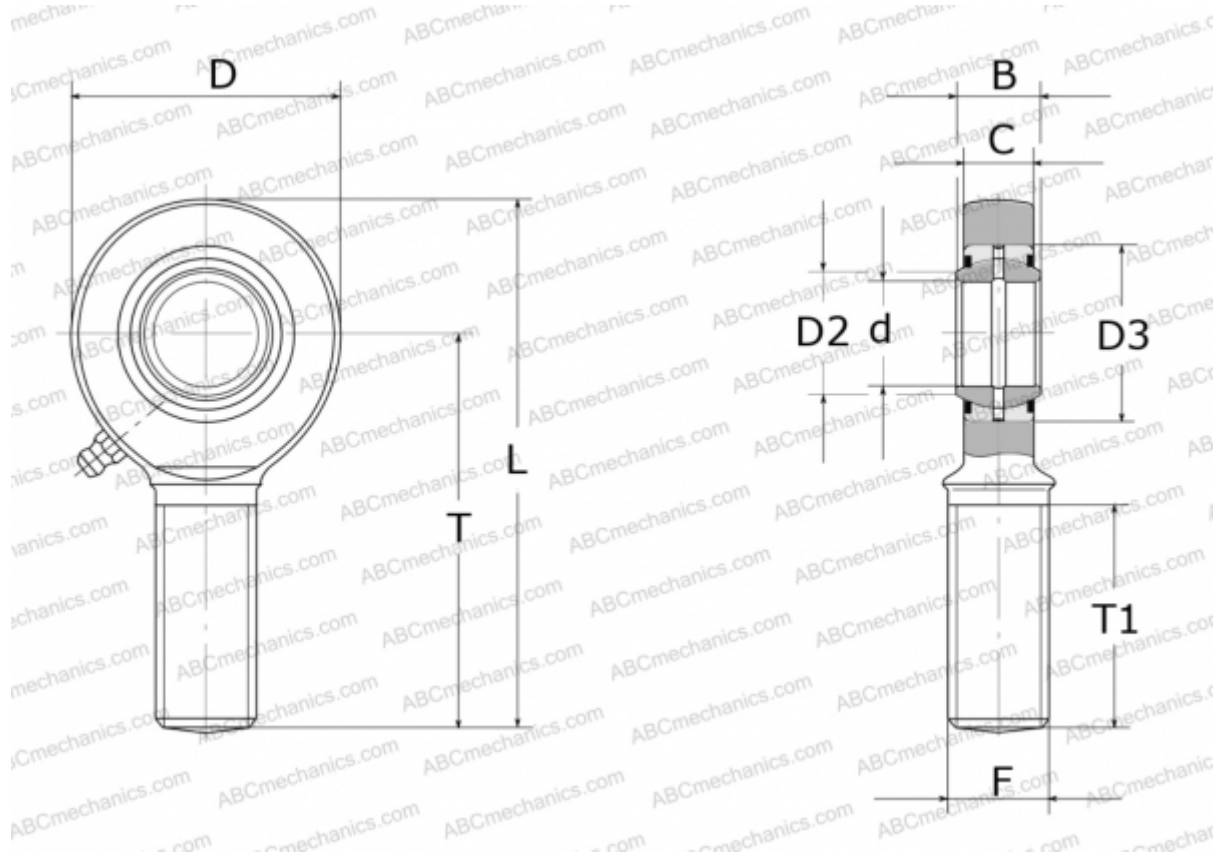

Technical specification

DIMENSIONS, MM

d	35,000
D	82,000
D2	39,800
D3	55,000
B	25,000
L	181,000
T	140,000
T1	82,000
C	21,000
F	M36X3

MANUFACTURER

[INA](#)