

## GF 25 DO INA

TYPE: Plain bearings, Spherical plain bearings and rod ends, Rod ends, Hydraulic, Requiring maintenance, with rectangular welding face, open design, series GF..-DO (INA)

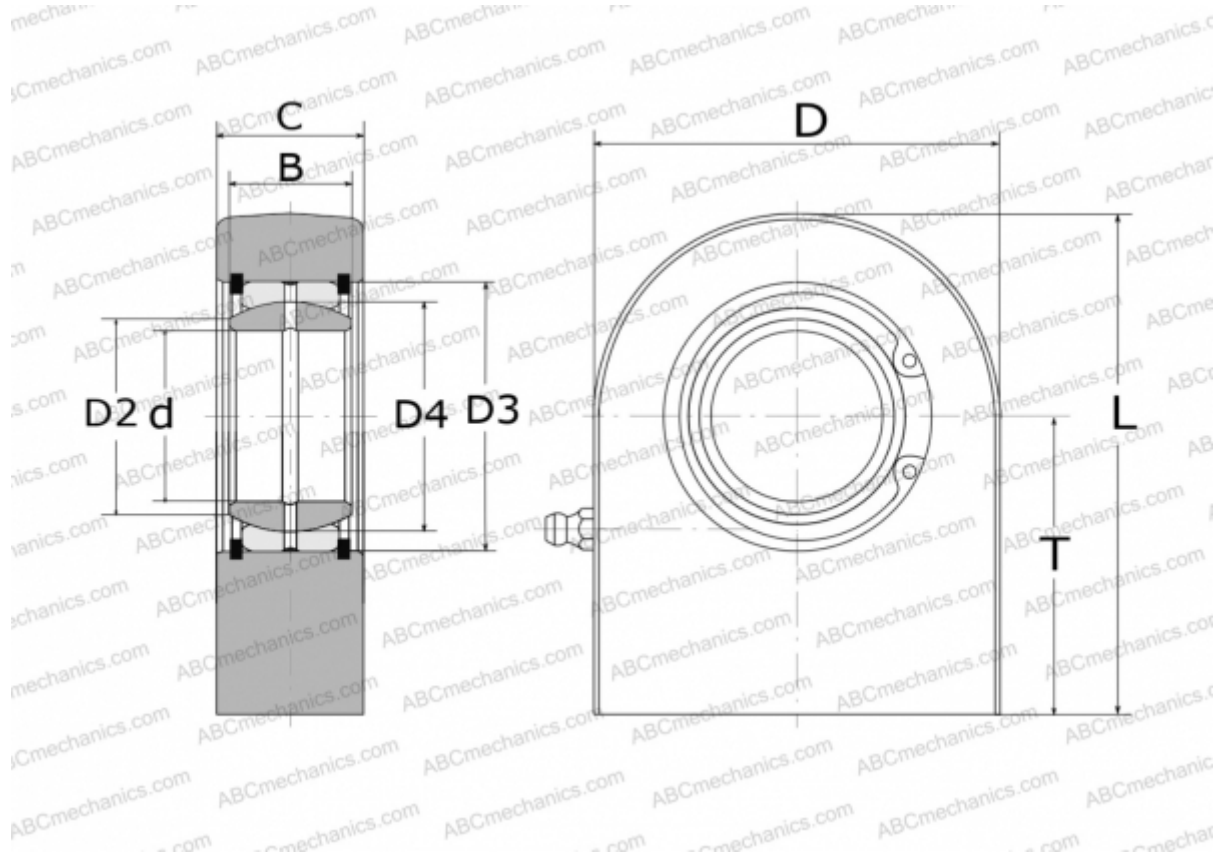

### Technical specification

#### DIMENSIONS, MM

d	25,000
D	55,000
D2	29,300
D3	42,000
D4	35,500
B	20,000
L	72,500
T	45,000
C	23,000

#### MANUFACTURER

[INA](#)