

GF 30 DO INA

TYPE: Plain bearings, Spherical plain bearings and rod ends, Rod ends, Hydraulic, Requiring maintenance, with rectangular welding face, open design, series GF..-DO (INA)

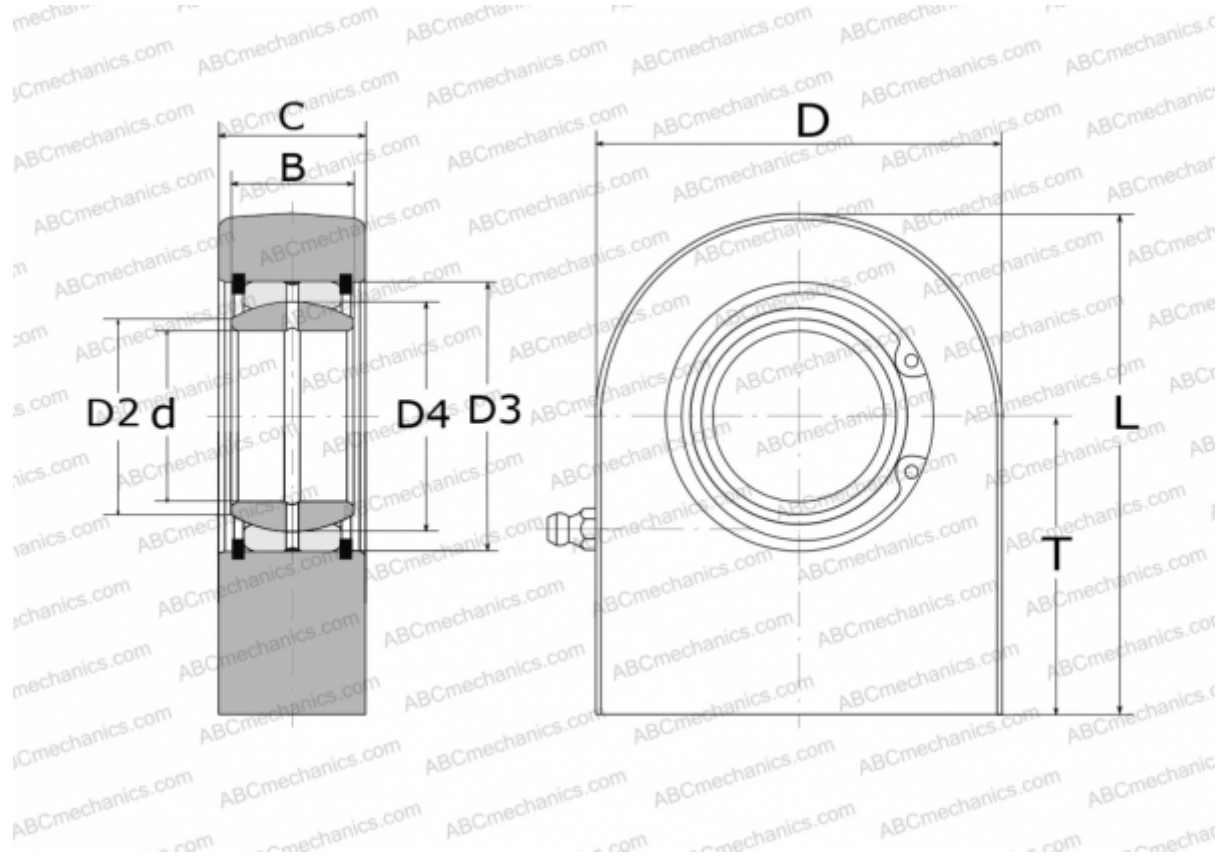

Technical specification

DIMENSIONS, MM

d	30,000
D	65,000
D2	34,200
D3	47,000
D4	40,700
B	22,000
L	83,500
T	51,000
C	28,000

MANUFACTURER

[INA](#)