

GF 35 DO INA

TYPE: Plain bearings, Spherical plain bearings and rod ends, Rod ends, Hydraulic, Requiring maintenance, with rectangular welding face, open design, series GF..-DO (INA)

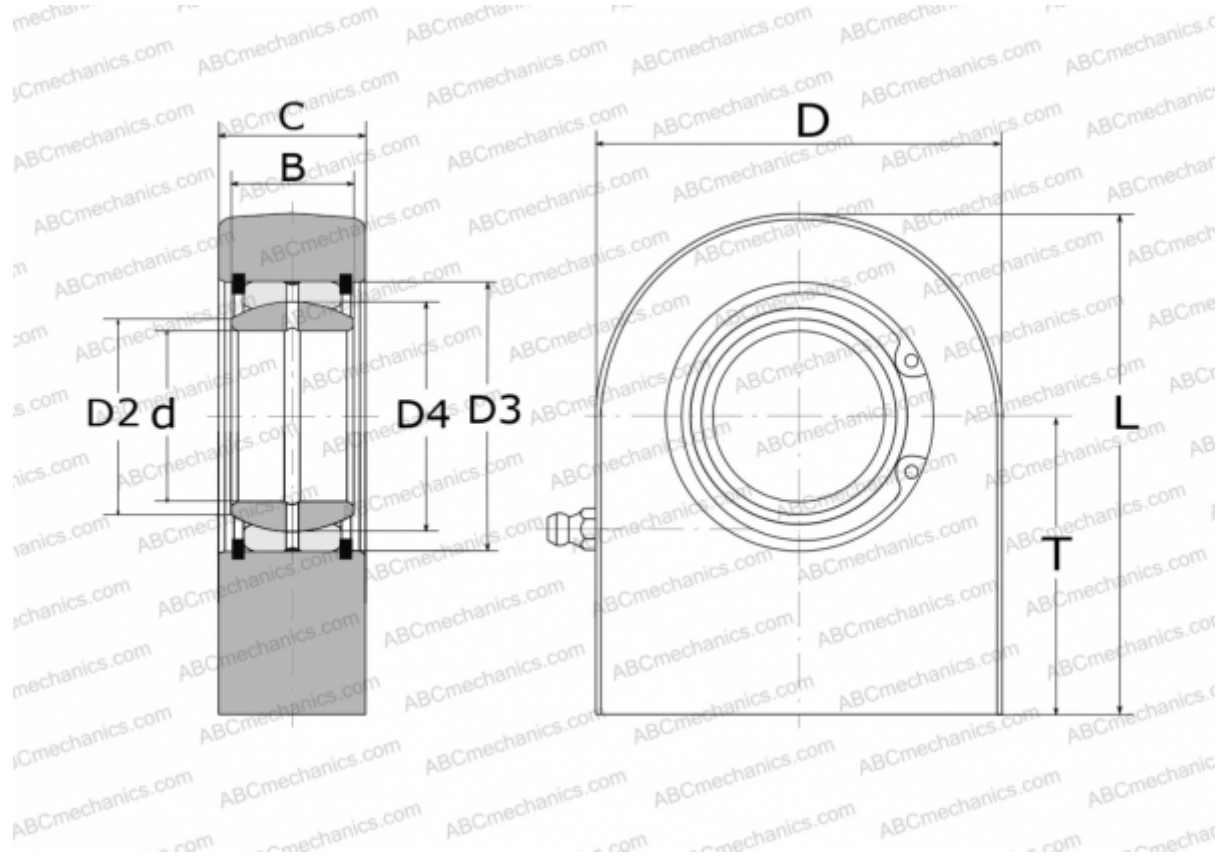

Technical specification

DIMENSIONS, MM

d	35,000
D	83,000
D2	39,800
D3	55,000
D4	47,000
B	25,000
L	102,500
T	61,000
C	30,000

MANUFACTURER

[INA](#)