

## GF 45 DO INA

TYPE: Plain bearings, Spherical plain bearings and rod ends, Rod ends, Hydraulic, Requiring maintenance, with rectangular welding face, open design, series GF..-DO (INA)

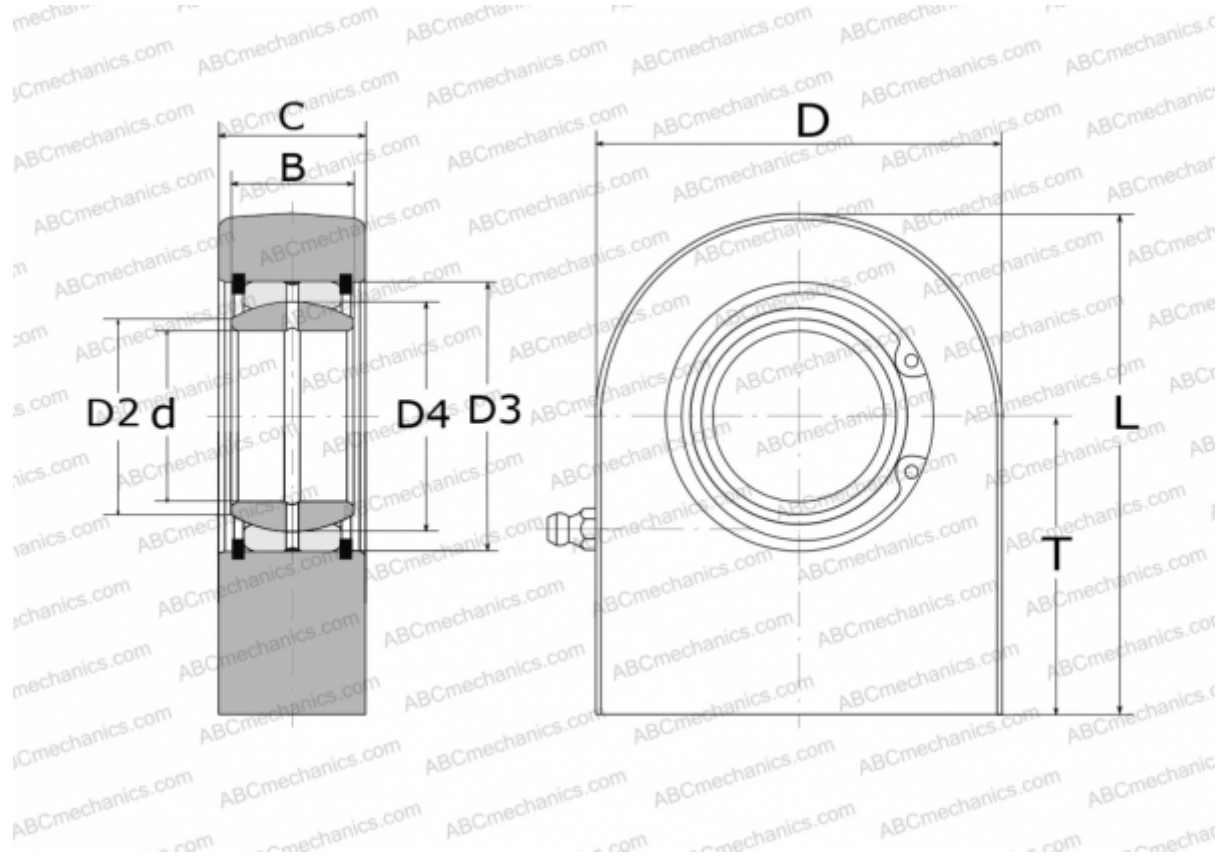

### Technical specification

#### DIMENSIONS, MM

d	45,000
D	110,000
D2	50,800
D3	68,000
D4	60,000
B	32,000
L	132,000
T	77,000
C	40,000

#### MANUFACTURER

[INA](#)