

GF 60 DO INA

TYPE: Plain bearings, Spherical plain bearings and rod ends, Rod ends, Hydraulic, Requiring maintenance, with rectangular welding face, open design, series GF..-DO (INA)

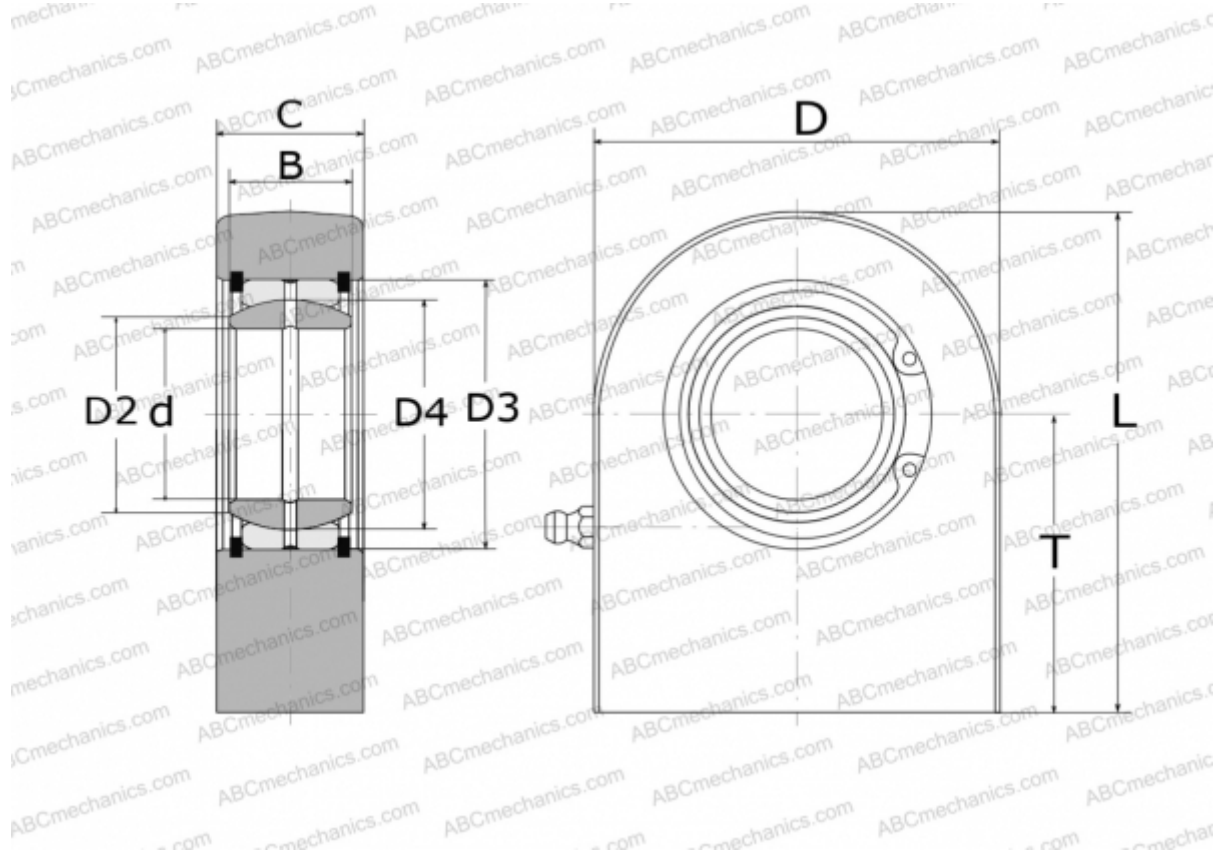

Technical specification

DIMENSIONS, MM

d	60,000
D	140,000
D2	66,800
D3	90,000
D4	80,000
B	44,000
L	170,000
T	100,000
C	50,000

MANUFACTURER

[INA](#)