

WJ-131714 NSK

Needle roller and cage assemblies

TYPE: Roller bearings, Needle, Single row, Needle roller and cage assemblies, Type WJ (NSK), inch size

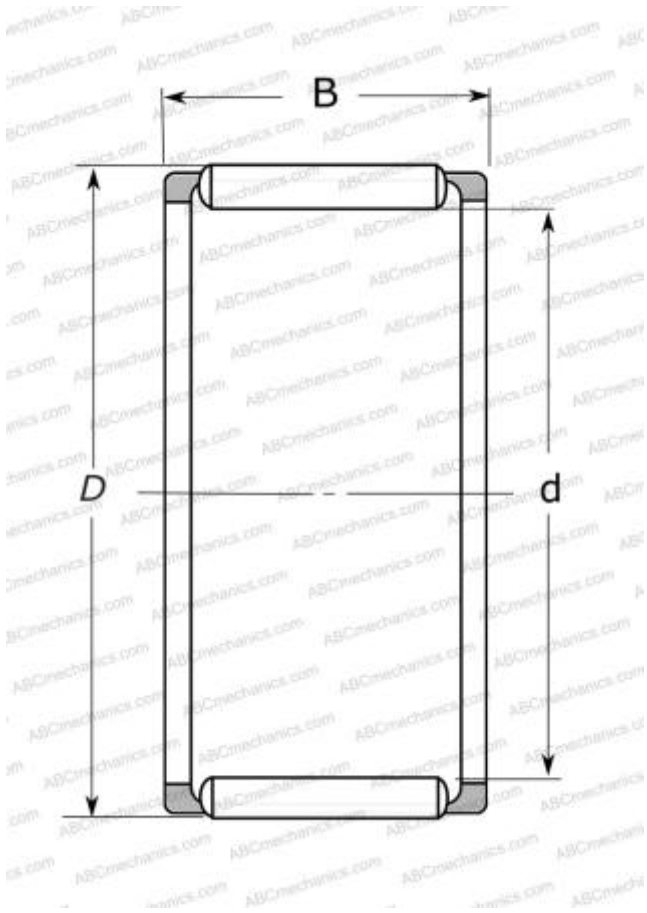

Technical specification

DIMENSIONS, MM

d	20,638
D	26,988
B	22,220

MANUFACTURER

[NSK](#)