

WJ-162116 NSK

Needle roller and cage assemblies

TYPE: Roller bearings, Needle, Single row, Needle roller and cage assemblies, Type WJ (NSK), inch size

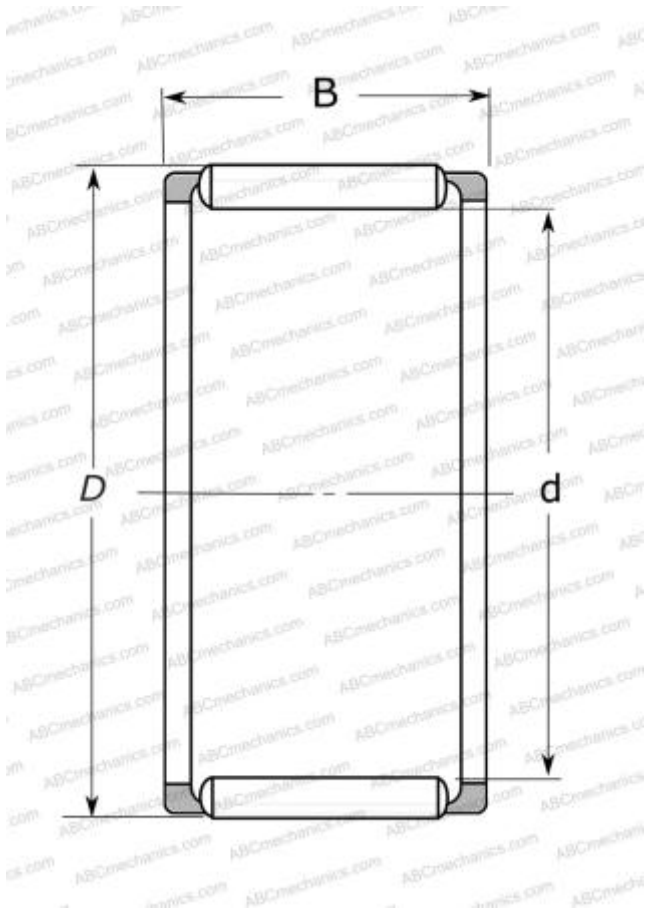

Technical specification

DIMENSIONS, MM

d	25,400
D	33,338
B	25,400

MANUFACTURER

[NSK](#)