

WJ-182420 NSK

Needle roller and cage assemblies

TYPE: Roller bearings, Needle, Single row, Needle roller and cage assemblies, Type WJ (NSK), inch size

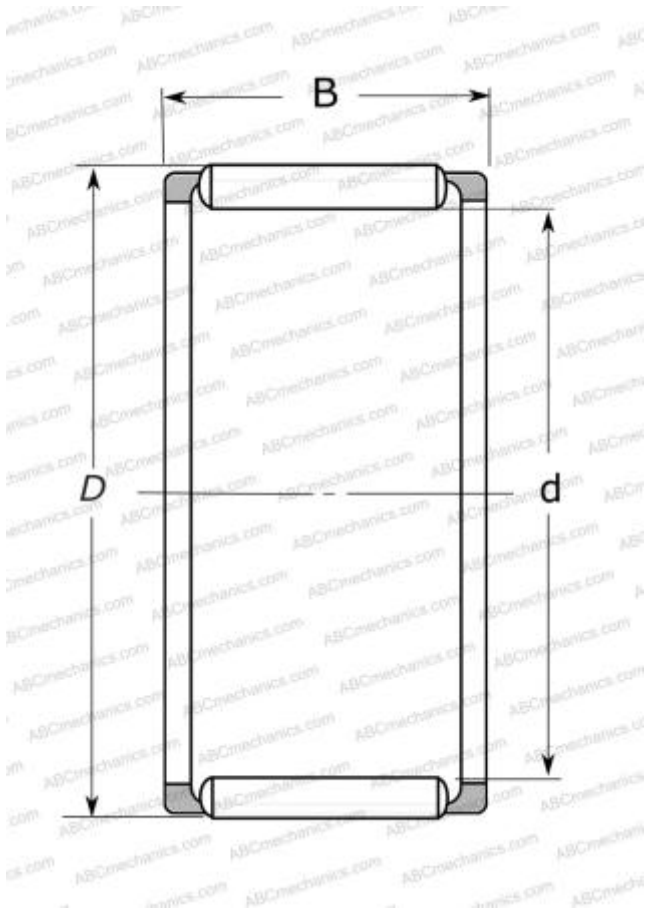

Technical specification

DIMENSIONS, MM

d	28,575
D	38,100
B	31,750

MANUFACTURER

[NSK](#)