

WJ-202612 NSK

Needle roller and cage assemblies

TYPE: Roller bearings, Needle, Single row, Needle roller and cage assemblies, Type WJ (NSK), inch size

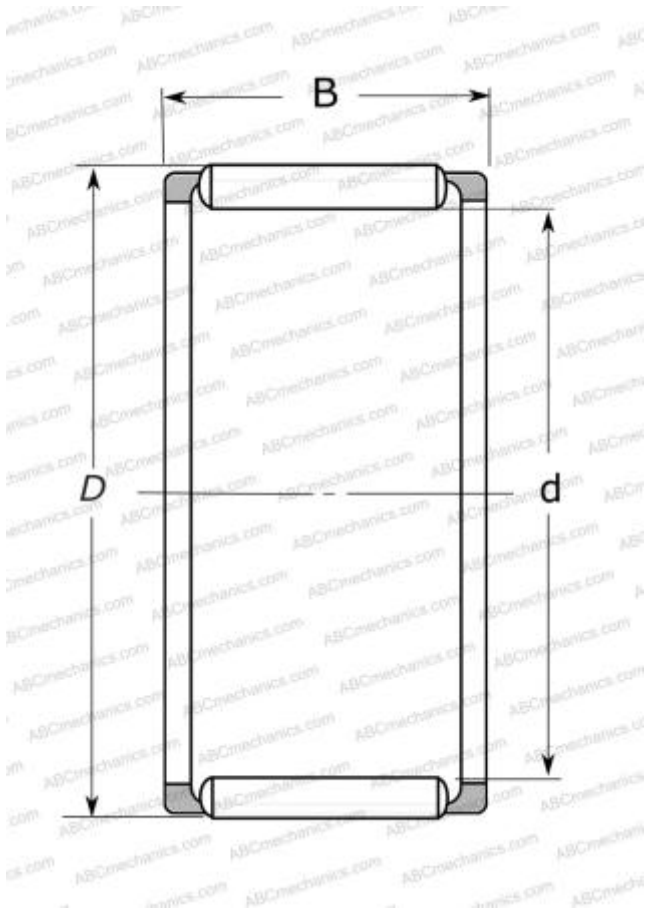

Technical specification

DIMENSIONS, MM

d	31,750
D	41,275
B	19,050

MANUFACTURER

[NSK](#)