

J-88 NSK

Needle roller bearings

TYPE: Roller bearings, Needle, Single row, Drawn cup, With cage, with open ends, type J, JH (NSK), inch size

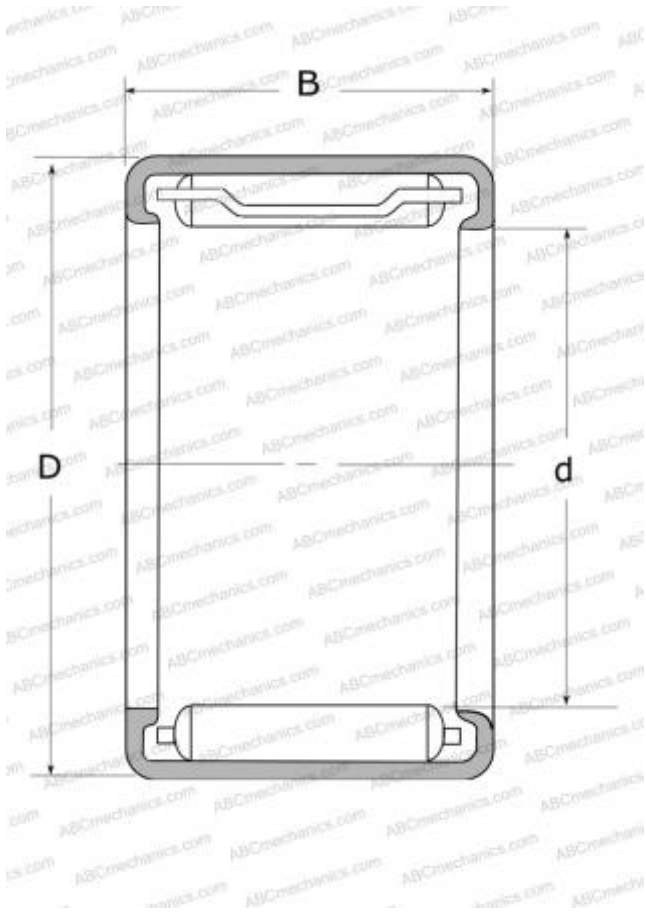

Technical specification

DIMENSIONS, MM

d	12,700
D	17,462
B	12,700

MANUFACTURER

[NSK](#)