

J-45 NSK

Needle roller bearings

TYPE: Roller bearings, Needle, Single row, Drawn cup, With cage, with open ends, miniature, type J, JH (NSK), inch size

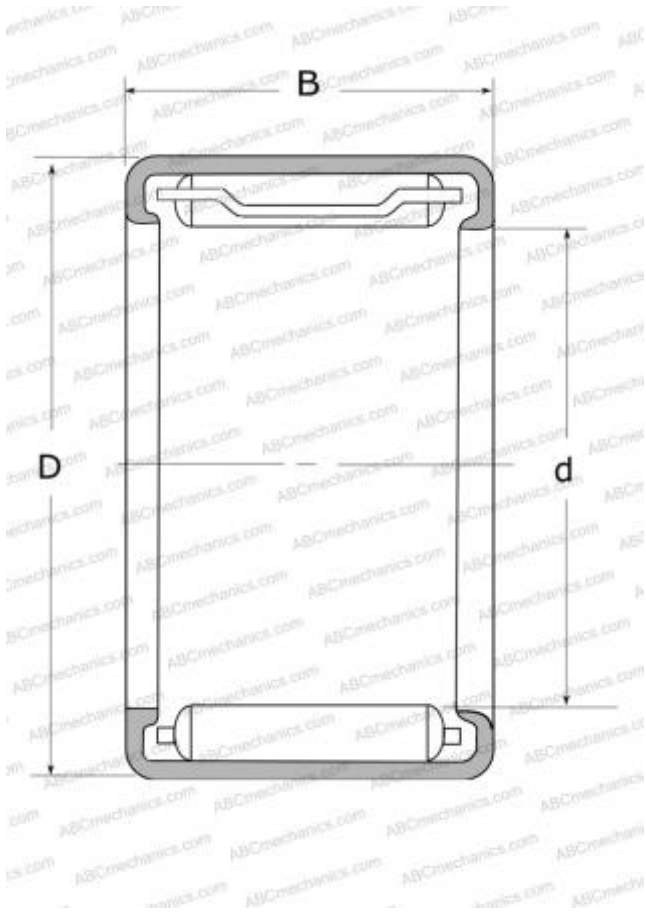

Technical specification

DIMENSIONS, MM

d	6,350
D	11,112
B	7,920

MANUFACTURER

[NSK](http://www.nsk.com)