

LM81512-1 NSK

Needle roller bearings

TYPE: Roller bearings, Needle, Single row, With machined rings with flanges, with an inner ring, Type LM (NSK)

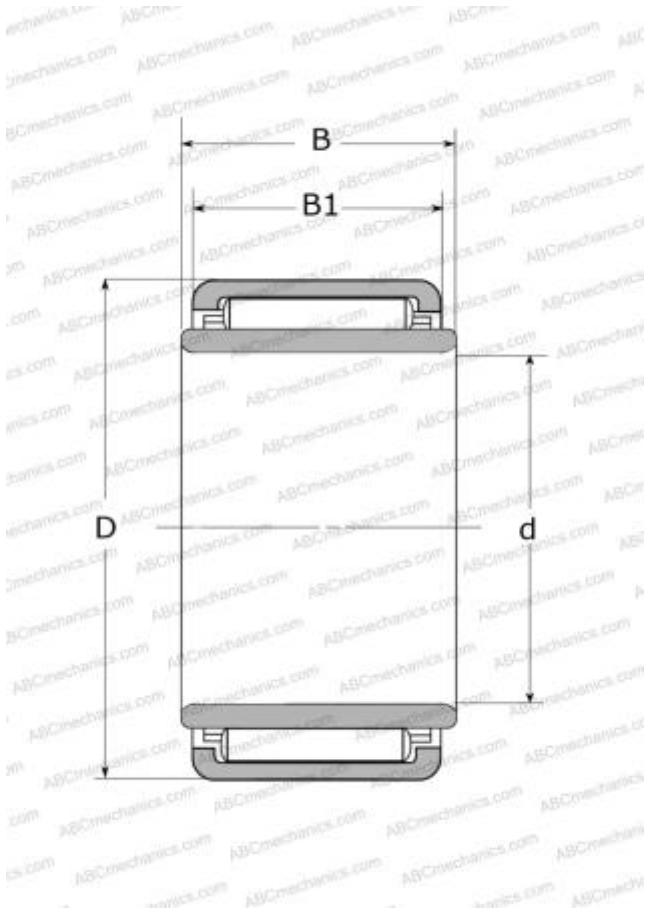

Technical specification

DIMENSIONS, MM

d	5,000
D	15,000
B	12,000
B1	12,000

MANUFACTURER

[NSK](#)

CALCULATION DATA

Basic dynamic load rating, C	5,500 kN
Basic static load rating, Co	4,600 kN
Limiting speed	45000 r/min