

LM91612-1 NSK

Needle roller bearings

TYPE: Roller bearings, Needle, Single row, With machined rings with flanges, with an inner ring, Type LM (NSK)

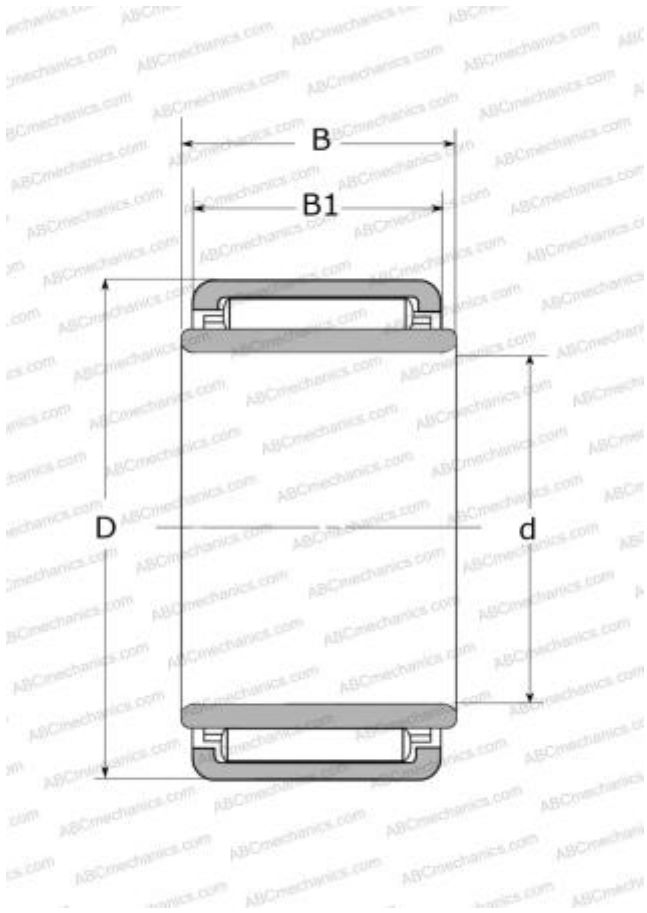

Technical specification

DIMENSIONS, MM

d	6,000
D	16,000
B	12,000
B1	12,000

MANUFACTURER

[NSK](#)

CALCULATION DATA

Basic dynamic load rating, C	6,150 kN
Basic static load rating, Co	5,400 kN
Limiting speed	40000 r/min