

LM121915 NSK

Needle roller bearings

TYPE: Roller bearings, Needle, Single row, With machined rings with flanges, with an inner ring, Type LM (NSK)

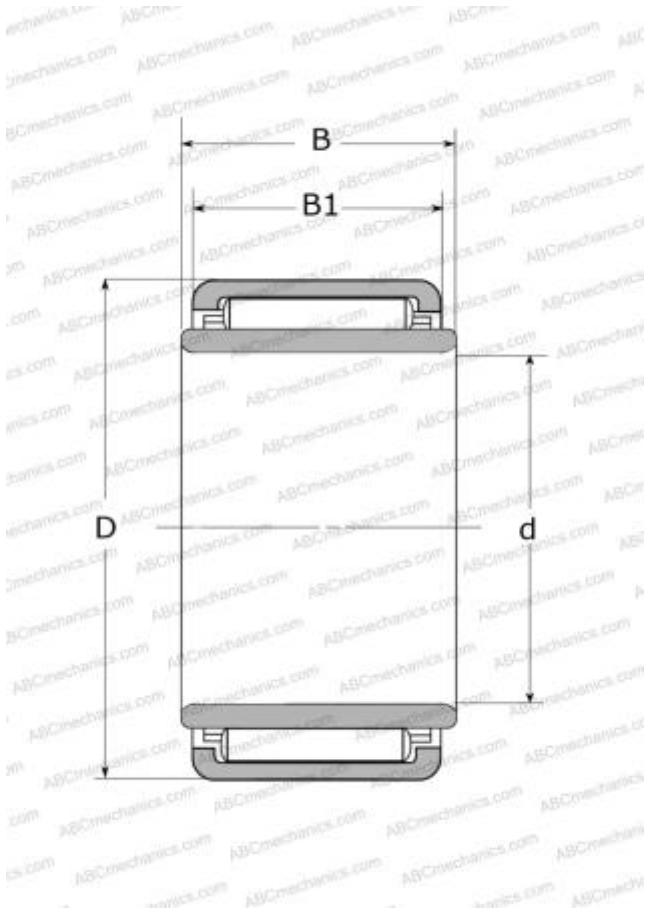

Technical specification

DIMENSIONS, MM

d	8,000
D	19,000
B	15,200
B1	15,000

MANUFACTURER

[NSK](#)

CALCULATION DATA

Basic dynamic load rating, C	8,700 kN
Basic static load rating, Co	8,950 kN
Limiting speed	30000 r/min