

LM121916-1 NSK

Needle roller bearings

TYPE: Roller bearings, Needle, Single row, With machined rings with flanges, with an inner ring, Type LM (NSK)

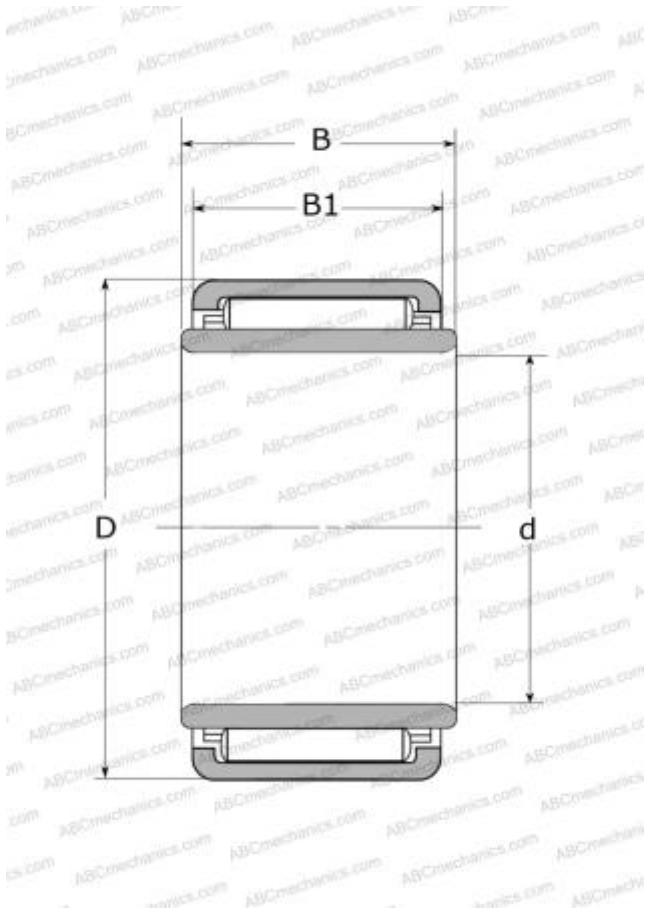

Technical specification

DIMENSIONS, MM

d	9,000
D	19,000
B	16,000
B1	16,000

MANUFACTURER

[NSK](#)

CALCULATION DATA

Basic dynamic load rating, C	9,400 kN
Basic static load rating, Co	9,850 kN
Limiting speed	30000 r/min