

GEC 380 TXA-2RS SKF

Spherical plain bearings

TYPE: Plain bearings, Spherical plain bearings and rod ends, Radial spherical plain bearings, Maintenance free, Series GEC..TXA-2RS (SKF), contact seals on both side, sliding surface hard chromium plated

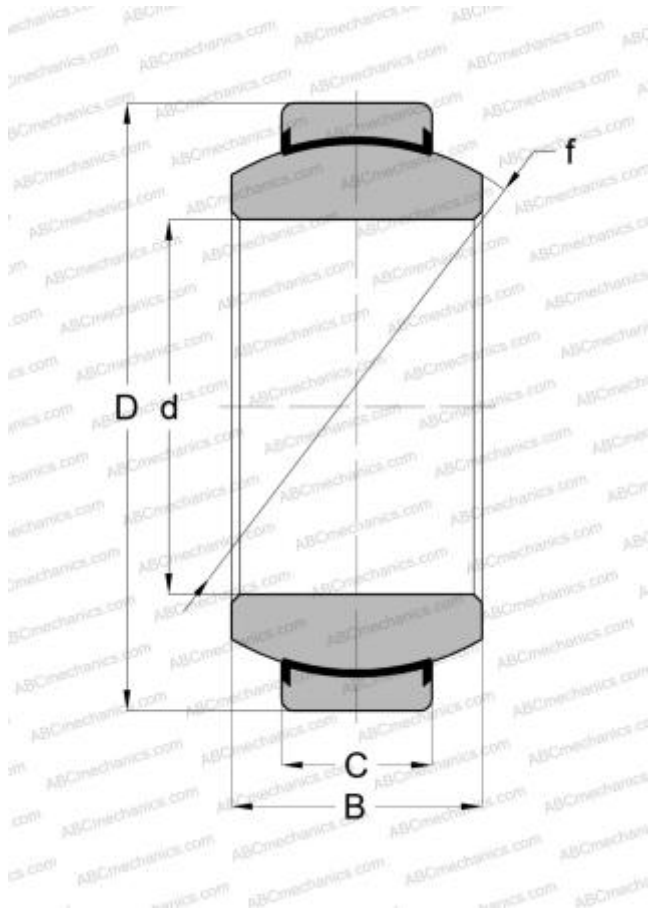

Technical specification

DIMENSIONS, MM

d	380,000
D	520,000
B	190,000
f	450,000
C	160,000

MANUFACTURER

[SKF](#)

CALCULATION DATA

Basic dynamic load rating, C	19300,000 kN
Basic static load rating, Co	32500,000 kN