

GEC 400 TXA-2RS SKF

Spherical plain bearings

TYPE: Plain bearings, Spherical plain bearings and rod ends, Radial spherical plain bearings, Maintenance free, Series GEC..TXA-2RS (SKF), contact seals on both side, sliding surface hard chromium plated

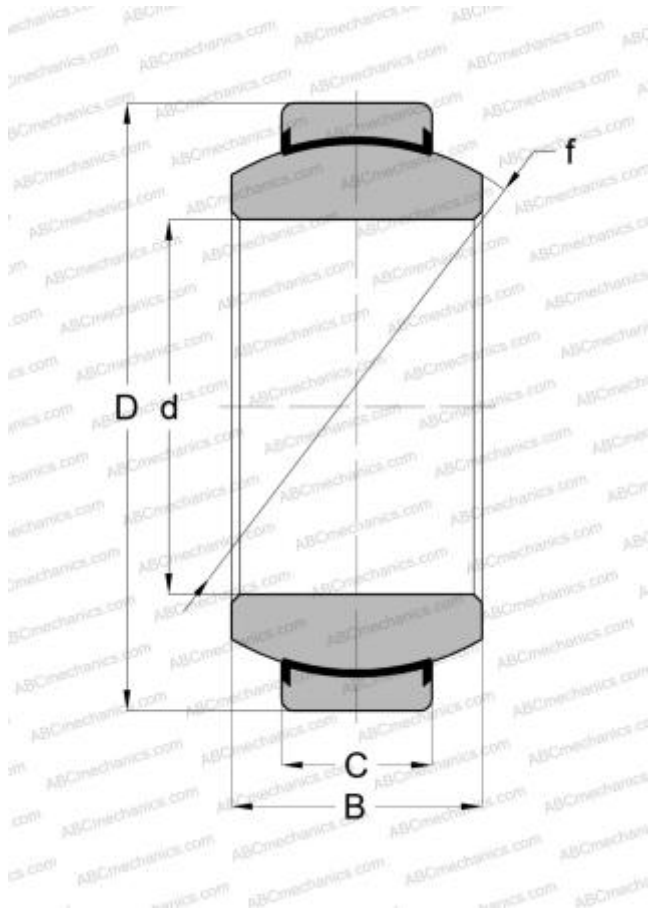

Technical specification

DIMENSIONS, MM

d	400,000
D	540,000
B	190,000
f	470,000
C	160,000

MANUFACTURER

[SKF](#)

CALCULATION DATA

Basic dynamic load rating, C	20400,000 kN
Basic static load rating, Co	34000,000 kN