

GEC 460 TXA-2RS SKF

Spherical plain bearings

TYPE: Plain bearings, Spherical plain bearings and rod ends, Radial spherical plain bearings, Maintenance free, Series GEC..TXA-2RS (SKF), contact seals on both side, sliding surface hard chromium plated

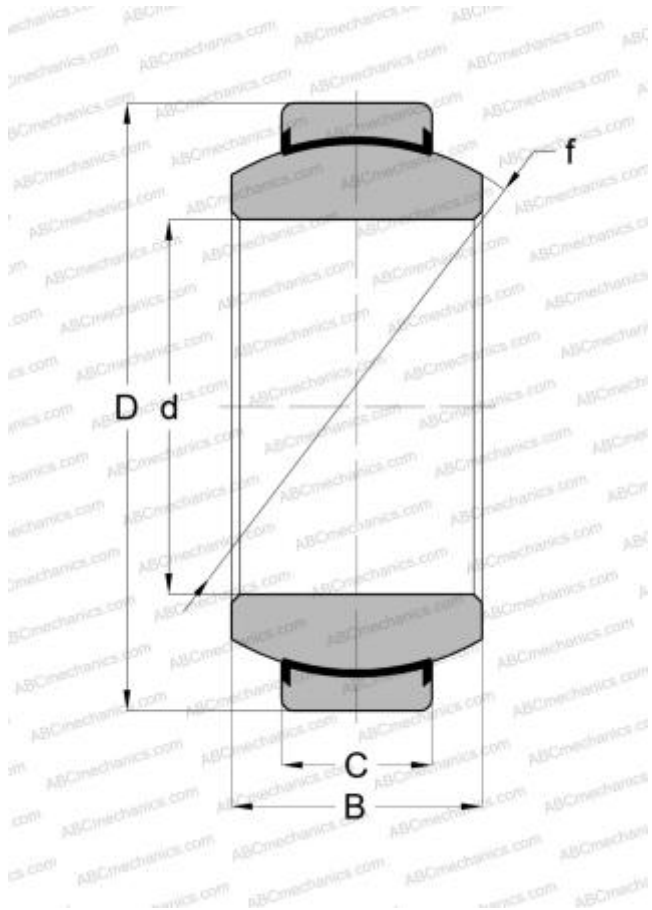

Technical specification

DIMENSIONS, MM

d	460,000
D	620,000
B	218,000
f	540,000
C	185,000

MANUFACTURER

[SKF](#)

CALCULATION DATA

Basic dynamic load rating, C	27000,000 kN
Basic static load rating, Co	45000,000 kN