

GE 10 AW FLURO

Spherical plain bearings

TYPE: Plain bearings, Spherical plain bearings and rod ends, Thrust spherical plain bearings, Maintenance free, Series GE..-AW, GX..F, steel/PTFE FRP

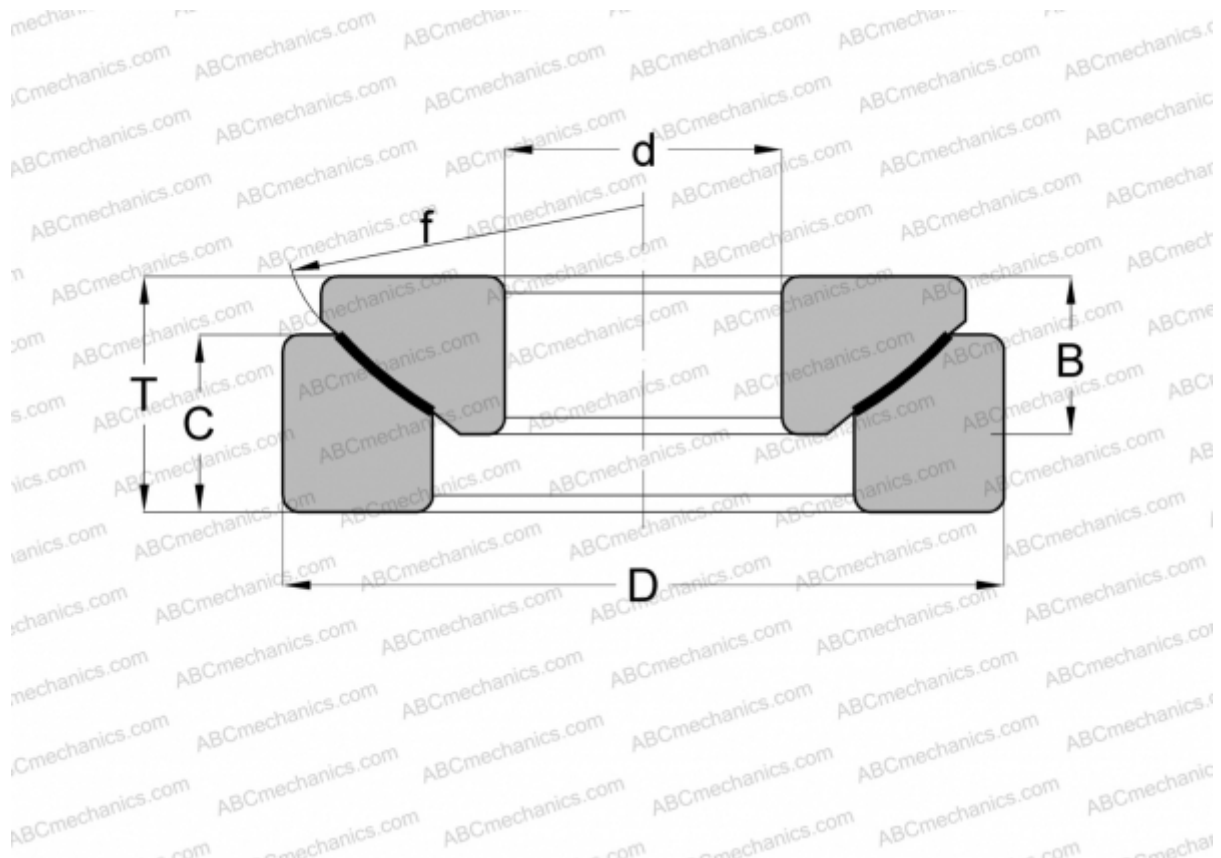

Technical specification

DIMENSIONS, MM

d	10,000
D	30,000
B	7,500
f	32,000
T	9,500
C	7,000

MANUFACTURER [FLURO](#)

INTERCHANGE

ABC	GE 10 AW
INA	GE 10 AW