

## GE 12 AW FLURO

Spherical plain bearings

TYPE: Plain bearings, Spherical plain bearings and rod ends, Thrust spherical plain bearings, Maintenance free, Series GE..-AW, GX..F, steel/PTFE FRP

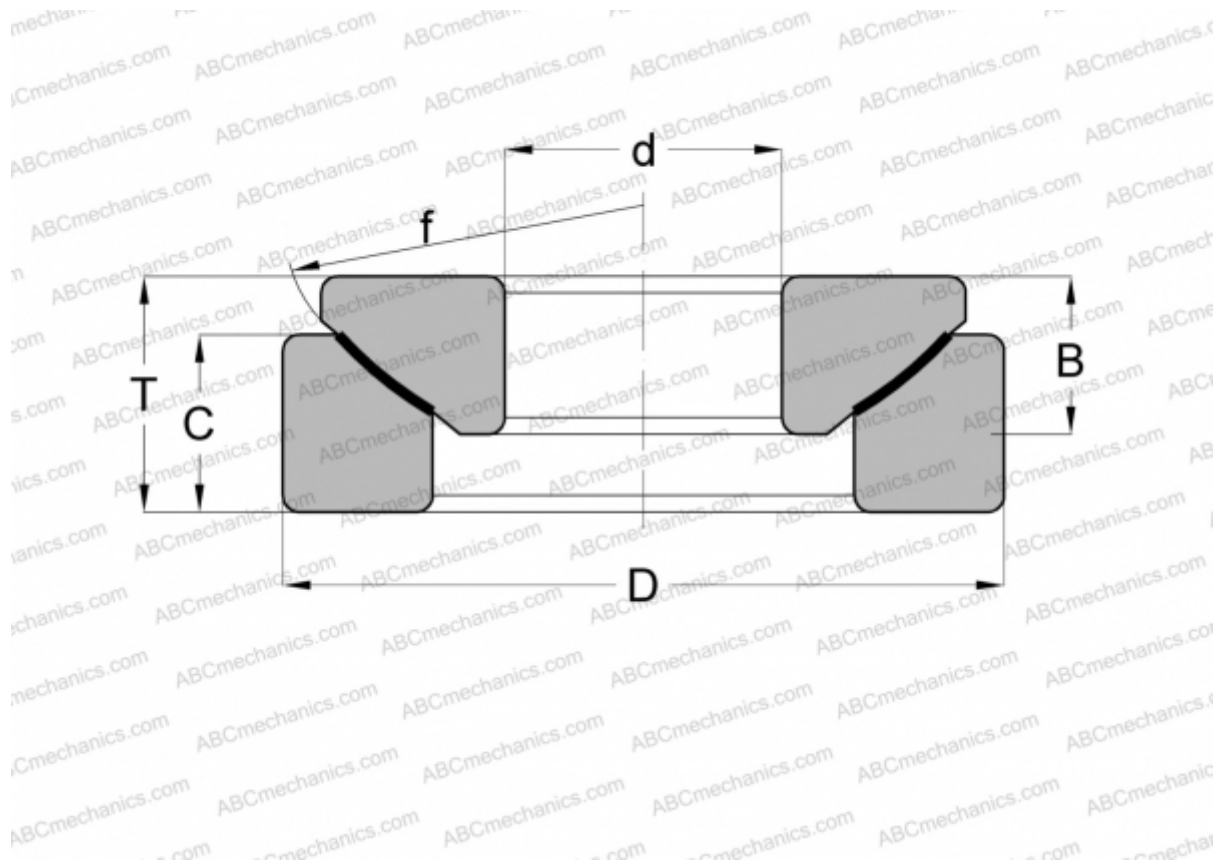

### Technical specification

#### DIMENSIONS, MM

d	12,000
D	35,000
B	9,500
f	38,000
T	13,000
C	9,300

**MANUFACTURER** [FLURO](#)

#### INTERCHANGE

ABC	<a href="#">GE 12 AW</a>
INA	<a href="#">GE 12 AW</a>