

60BAR10S TYNDBLP4A NSK

Axial angular contact ball bearing

TYPE: Ball bearings, Axial angular contact ball bearing, Single direction, Contact angle 30°, High speed, duplex, light preload (NSK)

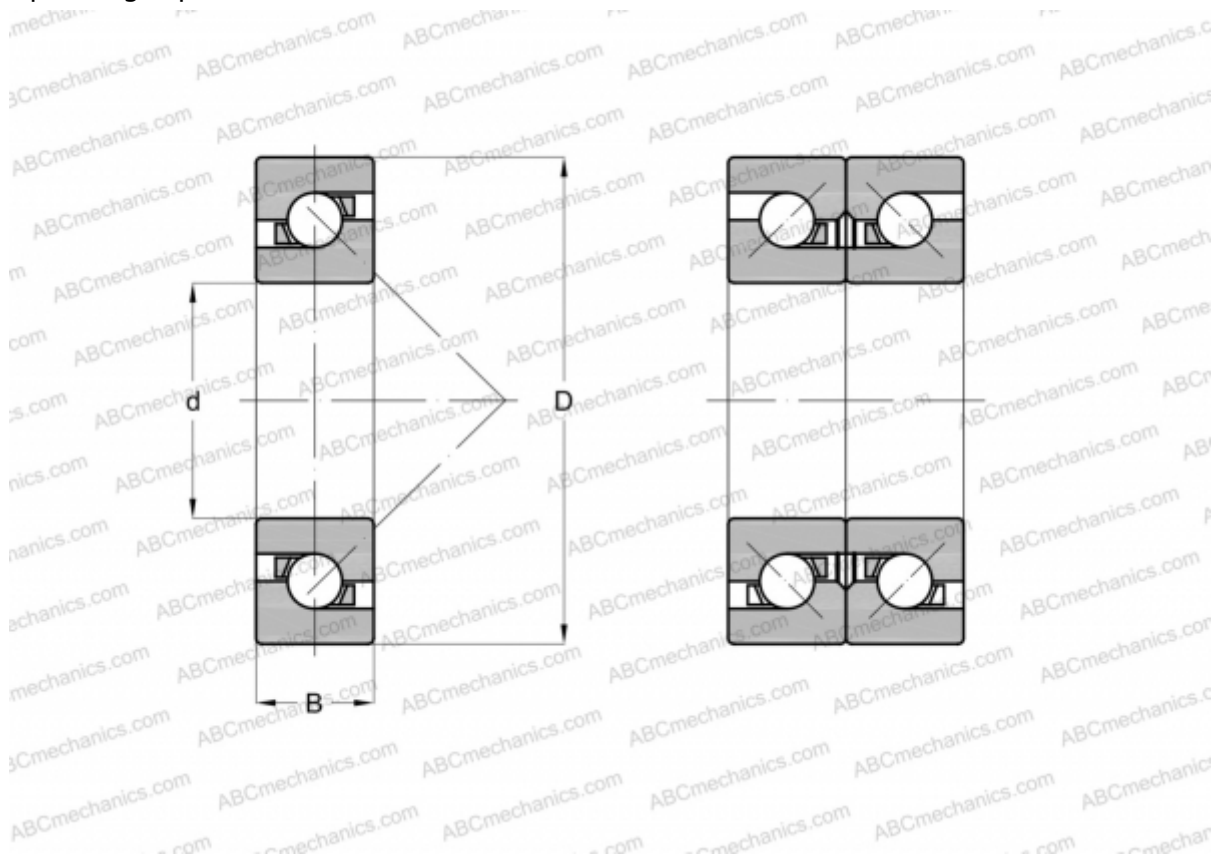

Technical specification

DIMENSIONS, MM

d	60,000
D	95,000
B	16,500

MANUFACTURER [NSK](#)

CALCULATION DATA

Basic dynamic load rating, C	18,900 kN
Basic static load rating, Co	38,000 kN
Attainable speed for grease lubrication	9700 r/min
Attainable speed for oil-air lubrication	12300 r/min