

85BAR10S TYNDBLP4A NSK

Axial angular contact ball bearing

TYPE: Ball bearings, Axial angular contact ball bearing, Single direction, Contact angle 30°, High speed, duplex, light preload (NSK)

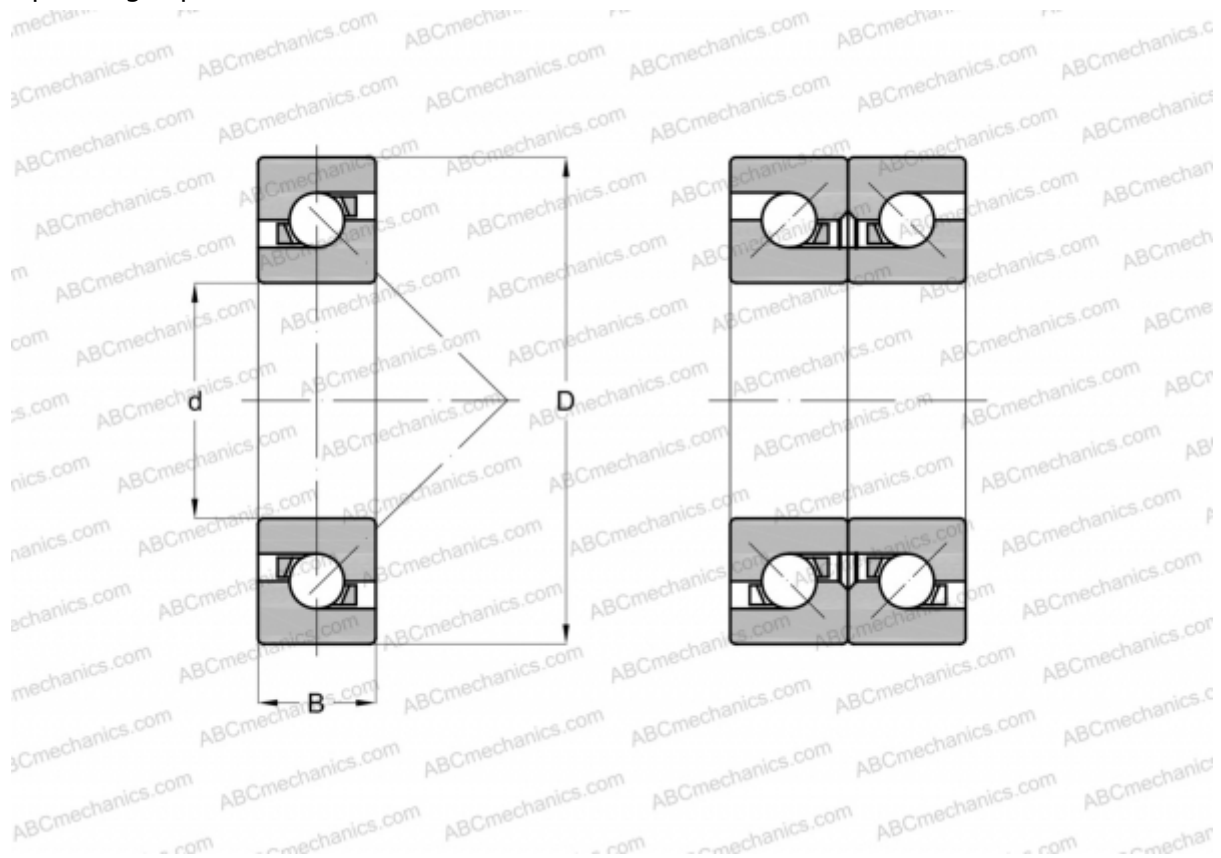

Technical specification

DIMENSIONS, MM

d	85,000
D	130,000
B	20,250

MANUFACTURER [NSK](#)

CALCULATION DATA

Basic dynamic load rating, C	32,500 kN
Basic static load rating, Co	71,500 kN
Attainable speed for grease lubrication	7000 r/min
Attainable speed for oil-air lubrication	8900 r/min