

95BAR10S TYNDBLP4A NSK

Axial angular contact ball bearing

TYPE: Ball bearings, Axial angular contact ball bearing, Single direction, Contact angle 30°, High speed, duplex, light preload (NSK)

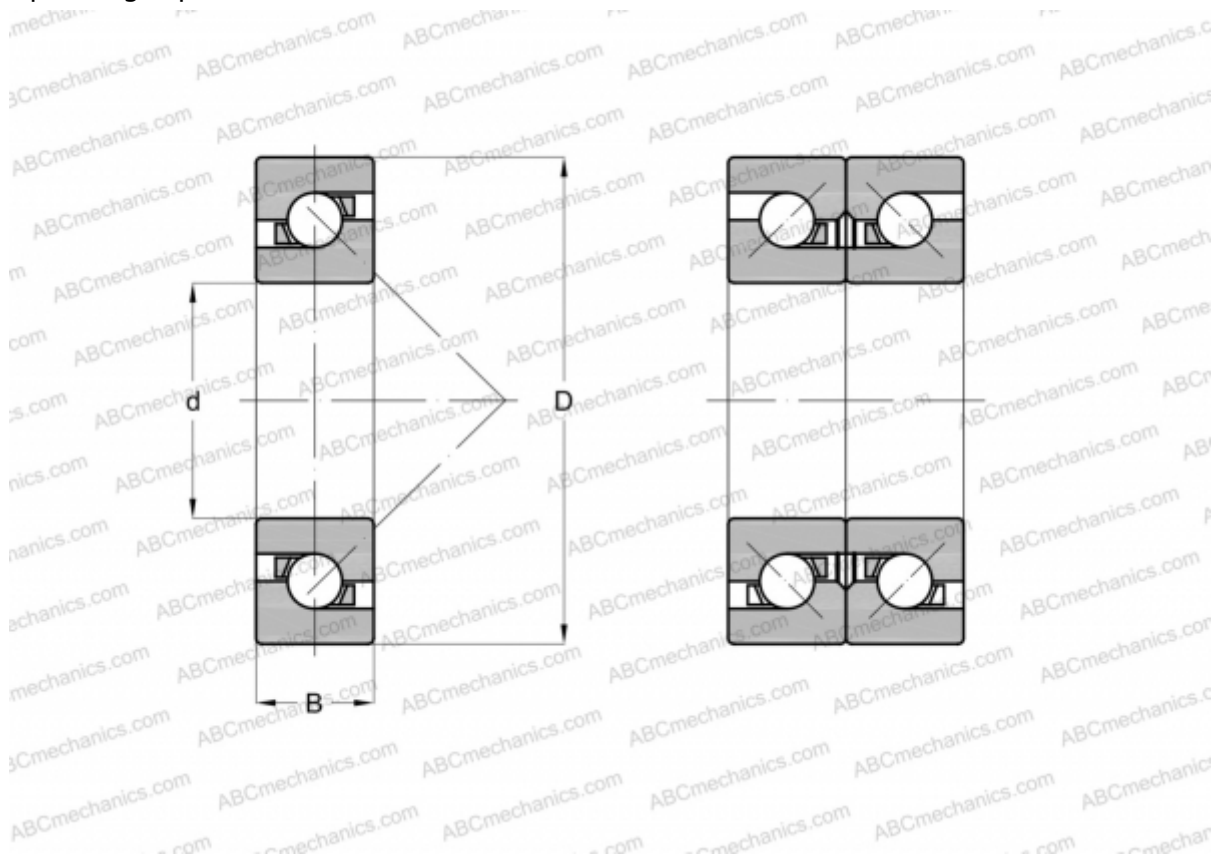

Technical specification

DIMENSIONS, MM

d	95,000
D	145,000
B	22,500

MANUFACTURER [NSK](#)

CALCULATION DATA

Basic dynamic load rating, C	43,000 kN
Basic static load rating, Co	96,500 kN
Attainable speed for grease lubrication	6300 r/min
Attainable speed for oil-air lubrication	8000 r/min